



Product Specification

# **XL125/160DC Series**

**125/160-Watt DC to DC**

**Power Supplies**

**Document No. 703152 Rev 07-01-19**

## Notices

*N2Power* is a wholly owned subsidiary of Qualstar Corporation.

*N2Power* and the *N2Power* logo are registered trademarks of Qualstar Corporation.

Copyright© 2009-2019 by Qualstar Corporation — All Rights Reserved

Information contained in this document is copyrighted by Qualstar Corporation and is intended for use by customers and prospective customers to evaluate and integrate our power supplies. Customers and prospective customers may reproduce this document as needed for these purposes. Reproduction in whole or in part for any other purpose or by any other party is prohibited without prior written permission from Qualstar Corporation.

Every effort has been made to keep the information contained in this document current and accurate as of the date of publication or revision. However, no guarantee is given or implied that the document is error-free or that it is accurate with regard to any specification.

*N2Power* reserves the right to modify the design or specification without notice. This specification may not be construed as a contractual obligation except as specifically agreed to by *N2Power* in writing at the time of order.

For warranty information refer to [www.n2power.com](http://www.n2power.com)

For information about this product specification, please write or call *N2Power* at:

### **N2Power**

1267 Flynn Road  
Camarillo, CA 93012

Fax: (805) 978-5212  
Phone: (805) 583-7744

E-Mail: [sales@n2power.com](mailto:sales@n2power.com)  
[www.n2power.com](http://www.n2power.com)

---

# Table of Contents

---

<b>1. Introduction</b> .....	<b>1-1</b>
1.1 Introduction .....	1-1
1.2 Safety Warning.....	1-2
1.3 Agency Compliance .....	1-2
<b>2. DC Input</b> .....	<b>2-1</b>
2.1 Input Requirements.....	2-1
2.2 Input Characteristics .....	2-1
2.3 Input Isolation.....	2-1
<b>3. DC Outputs</b> .....	<b>3-1</b>
3.1 Output Voltage Regulation.....	3-1
3.2 No Load Operation .....	3-2
3.3 Output Loading for Models XL125/160-1DC and XL125/160-8DC .....	3-2
3.4 Output Loading for Single-Output Models.....	3-3
3.5 Cooling.....	3-3
3.6 Output Ripple/Noise .....	3-4
3.7 Local and Remote Sensing.....	3-6
3.8 Parallel Operation: XL125/160-05DC CS thru XL125/160-56DC CS.....	3-7
3.9 Output Protection .....	3-8
3.10 Output Rise Time .....	3-9
3.11 Overshoot At Turn On/Turn Off.....	3-9
3.12 Output Transients .....	3-9
3.13 Closed Loop Stability.....	3-10
3.14 Capacitive Loading.....	3-10
<b>4. General Specifications</b> .....	<b>4-1</b>
4.1 Environmental .....	4-1
4.2 Mean Time Between Failures .....	4-1
4.3 Component Stress.....	4-1
4.4 Labeling/Marking.....	4-2
4.5 Weight .....	4-2
4.6 Mounting .....	4-2
4.7 Physical Dimensions.....	4-3
4.8 Mating Connectors .....	4-3
4.9 Output Grounding.....	4-5
4.10 Signal Pin Definitions.....	4-6

---

<b>5.</b>	<b>Efficiency .....</b>	<b>5-1</b>
5.1	XL125-1, -8DC Efficiency .....	5-1
5.2	XL125-05DC Efficiency .....	5-3
5.3	XL125-12...56DC Efficiency .....	5-4
5.4	XL160-1, -8DC Efficiency .....	5-9
5.5	XL160-05DC Efficiency .....	5-11
5.6	XL160-12...56DC Efficiency .....	5-12
<b>6.</b>	<b>Timing and Control .....</b>	<b>6-1</b>
6.1	Power Supply Timing .....	6-1
6.2	Power Good Signal/PS_OK Signal/Remote ON Input .....	6-1
6.3	Power Good LED .....	6-2
6.4	Power Sequencing: XL125/160-1DC and XL125/160-8DC .....	6-2
<b>7.</b>	<b>Ordering Information .....</b>	<b>7-1</b>

# 1.

# Introduction

## 1.1 Introduction

This specification defines the design and performance characteristics of the XL125/160DC-Series of open frame DC-input power supplies. These supplies provide single or multiple regulated DC outputs that are electrically isolated from the nominal 48VDC-input. All models are available in either 125-watt or 160-watt output power ratings. Single output models also have isolated 12V @ 1A auxiliary outputs and can be connected as plus or minus voltages. The 54V and 56V models have additional output insulation to meet the NEBS 1500VDC output isolation to chassis requirement.

The XL125/160DC-Series have similar output characteristics to N2Power's AC-input XL-Series but are distinguished from each other by the heat sink/cover color: black for AC-input models and aluminum (clear anodized) for DC-input models.

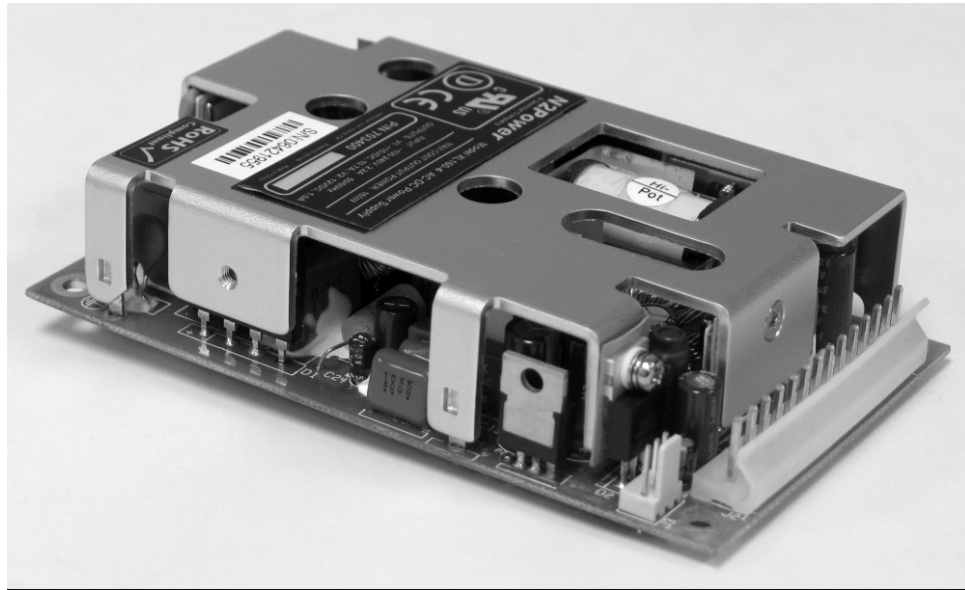


Figure 1-1 XL125/160DC (models differ slightly)

## 1.2 Safety Warning

### WARNING

This product is a component, not a stand-alone power supply. It must be mounted inside a protective enclosure to prevent accidental shock by contact with the supply. Lethal voltages are present while and after power is applied. Allow 1-minute for storage capacitors to discharge after removing power before handling the power supply.

The safety ground connection is made via one of the four mounting holes. It must be securely connected to Protective Earth. See Figure 4-2.

## 1.3 Agency Compliance






Safety	Complies with Standard	Remarks
United States	UL 60950-1 (2007) Second Edition UL 62368-1 Second Edition (Information Technology Equipment)	Leakage Current Hi-pot – 2121vdc for 1 second
Canada	CSA 22.2: 60950-1	
EU Council	2006/95/EC	Low Voltage Directive
International	IEC 60950-1 (2005) Second Edition IEC 62368-1 (2014) Second Edition	
EMC	Complies with Standard	Remarks
United States	FCC part 15, subpart B	Conducted emissions Limits per CISPR 22 Class B Tested to ANSI C63.4: 2003
EU Council	2004/108/EC	EMC Directive
International	EN 61204-3 (refers to the following) EN 55022 Class B  EN 55024 (refers to the following) EN 61000-4-3 EN 61000-4-4 EN 61000-4-5 EN 61000-4-6 EN 61000-4-11	Low Voltage Power Supplies – DC Output Conducted emissions Limits per CISPR 22 Class B Immunity Radiated Susceptibility Fast Transient/Burst Immunity Power Mains Surge Immunity RF Immunity Voltage Dips, Short Interruptions
Reduction of Hazardous Substances (RoHS)	Complies with Standard	Remarks
EU Council	2002/95/EC	RoHS Directive
Marks of Conformance		
United States & Canada	 (Underwriters Laboratories File E211115)	
Europe		
EU Council		
RoHS	 	

Table 1-1 Agency Compliance

## 2.1 Input Requirements

The following table defines the DC input power requirements for the XL125/160DC-Series, which are capable of supplying full rated power in continuous operation throughout the specified ranges of input voltages. The power supplies will automatically recover from DC power loss and are capable of starting under maximum load at the minimum DC input voltage described below.

Parameter	Minimum	Nominal	Maximum
Input Voltage	36 VDC	48 VDC	76 VDC
XL125-05DC	4.6 A @ 36 V	3.4 A @ 48 V	2.1 A @ 76 V
Other XL125DC Models	4.1 A @ 36 V	3.1 A @ 48 V	1.9 A @ 76 V
XL160-05DC	6.2 A @ 36 V	4.6 A @ 48 V	2.8 A @ 76 V
Other XL160DC Models	5.4 A @ 36 V	4.0 A @ 48 V	2.5 A @ 76 V

**Table 2-1 DC Input Requirements at Full-Load (approximate)**

## 2.2 Input Characteristics

Power-on inrush current is primarily a function of the power supply's input capacitance and the risetime of the input voltage. The XL125/160DC-Series presents an input capacitance of approximately 13 $\mu$ F (37mJ at 76VDC in). Additional passive resistance and inductance further limit the inrush current when power is applied.

For safety protection, 8-amp input fuses are provided on both the plus and minus inputs in case of excessive input voltage or an internal failure. These fuses are not user replaceable.

Repetitive ON/OFF cycling of the DC input voltage within the specified values shall not damage the power supply or cause the input fuses to fail.

The application of an input voltage below the minimums specified in Table 2-1, or of reversed polarity (below the rated maximum) shall not cause damage. The supply will not turn-on in either case, but will recover when the proper input voltage is applied.

## 2.3 Input Isolation

The input is electrically isolated from the output and chassis terminals with an isolation resistance in excess of 10-megaohms. To minimize conducted noise, capacitors are provided between the chassis mounting holes and the input and output terminals. There is approximately 1.7-microfarads between the input terminals and the chassis, and 0.1-microfarads between the output terminals and the chassis.

# 3.

# DC Outputs

## 3.1 Output Voltage Regulation

The DC output voltages shall remain within the Minimum and Maximum limits of Table 3-1 when measured at the power supply connector under all specified line, load and environmental conditions contained herein (V1 can maintain these tolerances at the load when 2-wire remote sense is implemented). The 12-volt auxiliary outputs float on models XL125/160-12DC through XL125/160-56DC. Thus, they can be used as either a positive or negative supply. On the XL125/160-05DC models the output returns of V1 and the 12V auxiliary output are tied together.

XL125: XL160:	Output	Rated Voltage	Regulation	Minimum (VDC)	Nominal (VDC)	Maximum (VDC)	Remote Sense
-1DC	V1	+3.3	±3%	3.201	3.300	3.399	V1/RTN
	V2	+5	±4%	4.848	5.050	5.252	V2
	V3	+12	±5%	11.400	12.000	12.600	-
	V4	-12	±5%	-11.400	-12.000	-12.600	-
-8DC	V1	none	-	-	-	-	-
	V2	+5	±4%	4.848	5.050	5.252	RTN only
	V3	+12	±5%	11.400	12.000	12.600	-
	V4	-12	±5%	-11.400	-12.000	-12.600	-
-05DC	V1	+5	±3%	4.850	5.000	5.150	V1/RTN
	V2	+12V <sub>aux</sub>	±5%	11.400	12.000	12.600	-
-12DC	V1	12	±3%	11.640	12.000	12.360	V1/RTN
	V2	+/-12V <sub>aux</sub>	±5%	11.400	12.000	12.600	-
-15DC	V1	15	±3%	14.550	15.000	15.450	V1/RTN
	V2	+/-12V <sub>aux</sub>	±5%	11.400	12.000	12.600	-
-24DC	V1	24	±3%	23.280	24.000	24.720	V1/RTN
	V2	+/-12V <sub>aux</sub>	±5%	11.400	12.000	12.600	-
-48DC	V1	48	±3%	46.560	48.000	49.440	V1/RTN
	V2	+/-12V <sub>aux</sub>	±5%	11.400	12.000	12.600	-
-54DC	V1	54	±3%	52.380	54.000	55.620	V1/RTN
	V2	+/-12V <sub>aux</sub>	±5%	11.400	12.000	12.600	-
-56DC	V1	56	±3%	54.320	56.000	57.680	V1/RTN
	V2	+/-12V <sub>aux</sub>	±5%	11.400	12.000	12.600	-

Table 3-1 XL125/160DC Output Voltage Specifications



## 3.2 No Load Operation

The power supply will operate with reduced output voltage regulation of +/-10% with all outputs unloaded. This no load condition will not damage the power supply or cause a hazardous condition, however the Power Good signal may not go true with less than a 5-watt load. The power supply will remain stable and operate normally after application of loads.

**CAUTION**

*Remove DC power prior to installing or removing secondary loads.*

## 3.3 Output Loading for Models XL125/160-1DC and XL125/160-8DC

The combined power of all outputs must not exceed the total power figures listed in Table 3-5. Additionally, the combined output power of V1 and V2 must not exceed the values listed in Table 3-3.

Output	Rated Voltage	Minimum Load	XL125 Maximum Load	XL125 Maximum Watts/Output	XL160 Maximum Load	XL160 Maximum Watts/Output
V1	+3.3 V	0.0 A	10.0 A	33	15.0 A	50
V2	+5 V	1.0 A	15.0 A	75	20.0 A	100
V3	+12 V	0.0 A	5.0 A	60	6.0 A	72
V4	-12 V	0.0 A	1.0 A	12	1.0 A	12

Table 3-2 XL125/160-1DC and -8DC Min/Max Load Currents

V1+V2 Power Restrictions	Forced CFM	Forced @ 50°C	Forced @ 70°C	Convection @ 50°C
XL125-1DC	5 CFM	80-watts	40-watts	75-watts
XL160-1DC	10 CFM	100-watts	50-watts	75-watts

Table 3-3 Maximum Continuous Combined V1+V2 Output Power vs. Available Cooling

## 3.4 Output Loading for Single-Output Models

These single-output models all have an auxiliary 12V output (V2, 12V AUX) that is typically used to drive a cooling fan. The load on this V2 output can vary from 0 to 1.0 amp and does not affect the Power Good or PS\_OK signals. Its output power detracts from that otherwise available to the V1 load. The maximum load currents listed in Table 3-4 assume V2 is unloaded. The V2 supply floats on these models. The combined power of all outputs must not exceed the total power figures listed in Table 3-5.

XL125: XL160:	Rated V1 Output	Power Good Load *	XL125 Maximum Load *	XL160 Maximum Load *
-05DC	5 V	1.00 A	25.0 A	32.0 A
-12DC	12 V	0.40 A	10.4 A	13.3 A
-15DC	15 V	0.33 A	8.3 A	10.7 A
-24DC	24 V	0.20 A	5.2 A	6.7 A
-48DC	48 V	0.09 A	2.6 A	3.3 A
-54DC	54 V	0.09 A	2.3 A	3.0 A
-56DC	56 V	0.09 A	2.2 A	2.9 A

\* Minimum load needed for the Power Good signal to go high and the PS\_OK signals to go low.

\* Assuming no load on the V2 output.

**Table 3-4 Min/Max Load Currents for single-output models**

## 3.5 Cooling

The maximum continuous output power is always a function of the cooling airflow and ambient temperature. The maximum output power is attainable with the listed Forced CFM (cubic feet per minute) of air flow at a temperature of 50°C or less. The airflow may be co-planar with the circuit board or impinge down on the top of the heat sink/cover. See Section 3.5.1 for derating output power above 50°C. The total available output power is reduced considerably with unrestricted convection cooling. Unrestricted means there are no nearby obstructions that would impede the convection cooling process.

Model	Forced CFM	Forced @ 50°C	Forced @ 70°C	Convection @ 50°C
XL125	5 CFM	125-watts	62.5-watts	85-watts
XL160	10 CFM	160-watts	80-watts	85-watts

**Table 3-5 Maximum Continuous Total Output Power vs. Available Cooling**

### 3.5.1 High Temperature Derating

The XL125/160DC can be operated at elevated temperatures by derating the total maximum output power (or current) by 2.5%/°C from 50°C to 70°C (see Figure 3-1).

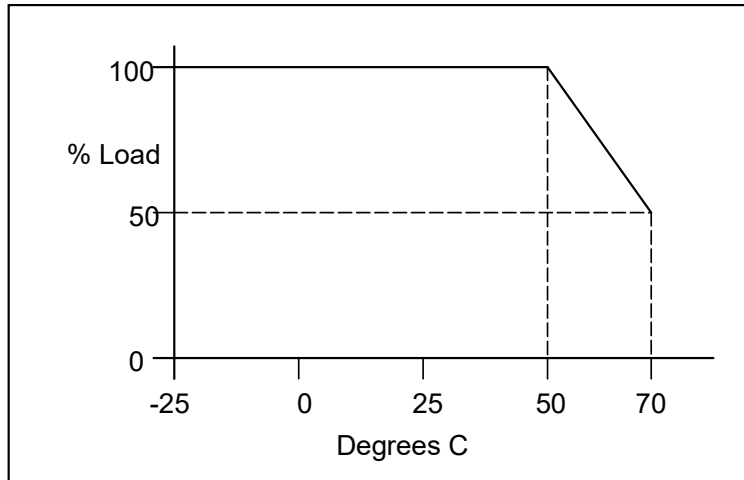


Figure 3-1 Derating Curve for Elevated Temperature Operation

## 3.6 Output Ripple/Noise

Output ripple voltage and noise are defined as periodic or random signals over a frequency band of 10 Hz to 20 MHz. Measurements are to be made with an oscilloscope with at least 20 MHz bandwidth. Outputs should be bypassed at the connector with a 0.1  $\mu$ F ceramic disk capacitor and a 10  $\mu$ F tantalum capacitor to simulate system loading (see Figure 3-2). Ripple and noise shall not exceed the limits specified in the following tables.

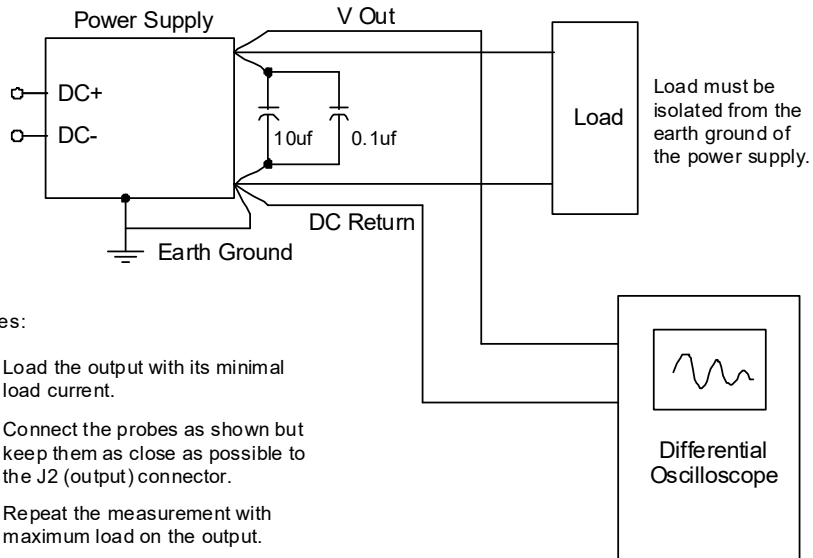
### 3.6.1 Ripple and Noise

The ripple voltage of the outputs is measured at the pins of the mating connector. Ripple and noise shall not exceed the limits specified in Table 3-6 under any condition of line voltage and frequency specified in Section 2.1 and DC loading specified in Section 3.3.

XL125: XL160:	Output	Voltage	Maximum Ripple+Noise (peak-to-peak)
-1DC, -8DC	V1	+3.3 V	50 mV
	V2	+5 V	50 mV
	V3	+12 V	120 mV
	V4	-12 V	120 mV
-05DC through -56DC	V1	5 V	50 mV
	V1	12 V	120 mV
	V1	15 V	150 mV
	V1	24 V	240 mV
	V1	48 V	480 mV
	V1	54 V	540 mV
	V1	56 V	560 mV
	V2	12 V	120 mV

**Table 3-6 Maximum Ripple+Noise (P-P)**

### 3.6.2 Ripple/Noise Test Setup



**Figure 3-2 Ripple Noise Measurement Setup**

### 3.7 Local and Remote Sensing

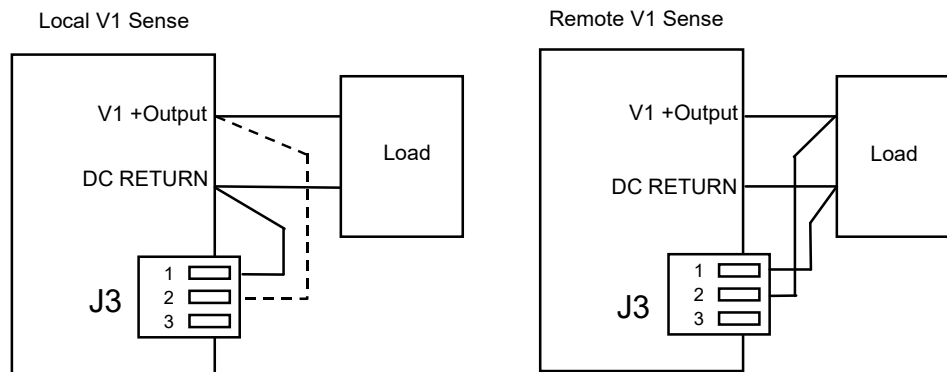
Remote sensing is provided to compensate for voltage drops in the V1 (+ Output) and DC RETURN connections to the load. For every model, the 0V Sense input must be connected to either one of the DC Return pins of the supply or the DC Return terminal at the load. This is necessary for the power supply to guarantee it will meet specification. Connecting it to the return side of the load will reduce the voltage drop in the external return wiring.

If the V1 Sense input is left open, the V1 output will raise slightly (approximately 0.3V) above its load regulation specification. The V1 output will meet its load regulation specification when the V1 Sense pin is connected to one of the V1 output pins. Connecting the V1 Sense pin to the V1 output at the load will reduce the voltage drop in the external V1 wiring.

#### 3.7.1 Local and Remote Sensing: XL125/160-1DC, XL125/160-8DC

The V1 Sense input need not be connected for the X125/160-8, as it has no V1 output. The XL125/160-1DC can compensate for up to 0.2V drop in each side (+Output and RETURN). Figure 3-3 shows the required and optional remote sensing connections. Refer to Table 4-7 for the pin definition of the XL125/160 connectors.

Single pin J4 should be connected to the V2 (+5V) load to improve regulation at the load.



**Figure 3-3 Remote V1 Sensing: XL125/160-1DC and XL125/160-8DC**

#### 3.7.2 Local and Remote Sensing: XL125/XL160-05DC [CS]

Up to 0.2V in the return and 0.2V in the V1 connection may be compensated. Figure 3-4 shows the required and optional remote sensing connections. J3 actually has five pins but only the first three are shown below. Refer to Table 4-7 for the pin definition of the XL160 connectors.

The CS models contain an internal OR-ing diode (MOSFET) so that V1 output of multiple power supplies may be connected in parallel. Follow the same sense wiring for each paralleled supply as if it were a single supply.

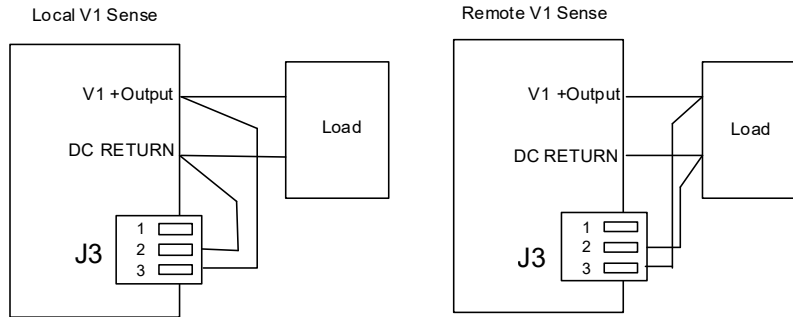


Figure 3-4 Remote Sensing Wiring: XL125/XL160-05DC [CS]

### 3.7.3 Local and Remote Sensing: XL125/160-12DC [CS] through XL125/160-56DC [CS]

Up to 0.5V in the return and 0.5V in the V1 connection may be compensated. Figure 3-5 shows the required and optional remote sensing connections. J3 actually has five pins but only the first three are shown below. Refer to Figure 4-3 for the pin definition of the connectors.

These models contain internal OR-ing diodes so that V1 output of multiple power supplies may be connected in parallel. Follow the same sense wiring for each paralleled supply as if it were a single supply.

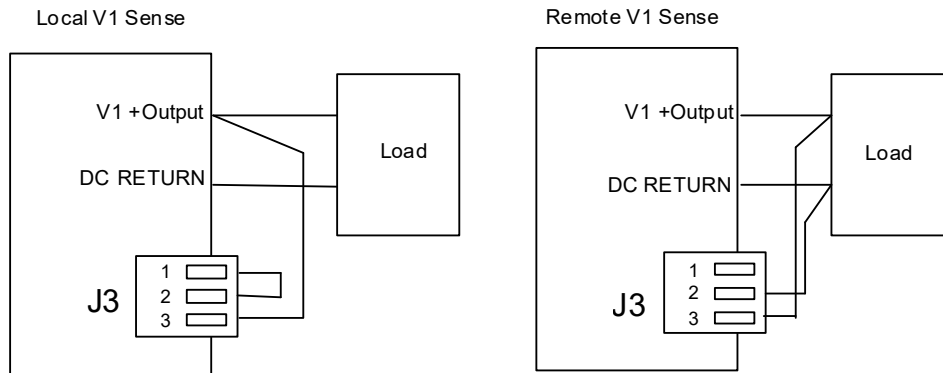


Figure 3-5 Remote Sensing Wiring: XL125/160-12DC through XL125/160-56DC

## 3.8 Parallel Operation: XL125/160-05DC CS thru XL125/160-56DC CS

Two, three or four power supplies may be connected in parallel to provide higher output power. They can also be used in a N+1 configuration to provide higher output power and greater reliability. Each of these models has a built-in output OR-ing diode (or MOSFET) and a Current Share signal for parallel operation.

### 3.8.1 Current Sharing Connections

The Current Share signal (see Table 4-7) of each supply operating in parallel must be connected together. Power sharing does not require the 0V Sense signals be connected together, but the sharing accuracy may not meet published specification unless they are also connected together.

Power Good signals may be wire OR-ed together, but this is not recommended, as a failing power supply will pull the signal low. They should be monitored individually by the user's system.

### 3.8.2 Current Share Accuracy

When all the current share signals are connected together and all the 0V Sense signals are connected together, the load delivered by any two supplies of the sharing supplies will not vary by more than 10% at full load.

### 3.8.3 Transients

The output rise time and monotonic requirements of Section 6.3 may not be met where the load exceeds 125/160 watts, because of the difference in start-up times of the paralleled power supplies.

When the input power to one of the parallel power supplies is disconnected or reconnected, or a power supply fails, the transient on the V1 output is within five (5) percent of nominal output voltage, although the output voltage may ramp to a new nominal voltage within the regulation band.

## 3.9 Output Protection

There are three different output protection schemes designed to protect the load and the supply from component failures and extraordinary circumstances.

### 3.9.1 Over Temperature Protection

If the supply is operated without adequate cooling, it will sense an over-temperature condition and shut itself down. It will automatically restart when it has cooled down to below its maximum operating temperature.

### 3.9.2 Over Voltage Protection

No single fault is able to cause a sustained over voltage condition on any main output. When an over-voltage condition occurs, the power supply will shut down and then periodically attempt to restart. The supply will shut down under the following over voltage conditions:

Output	Minimum	Nominal	Maximum
3.3 V	3.76 V	4.2 V	4.8 V
5.0 V	5.74 V	6.3 V	7.0 V
12.0 V	13.5 V	15.0 V	16.5 V
15.0 V	16.87 V	18.75 V	20.6 V
24.0 V	27.0 V	30.0 V	33.0 V
48.0 V	54.0 V	58.0 V	64.0 V
54.0 V	60.8V	64.8V	74.3V
56.0 V	63.0V	70.0V	77.0V

Table 3-7 Over Voltage Protection Limits

### 3.9.3 Over Current Protection

Overload currents applied to any output will cause the output to shut down. The power supply will periodically attempt to restart until the over-current condition is removed. This feature is tested with an ever-increasing load at a rate of 10 A/second starting at maximum load.

Pulsating loads of 150% of the rated output can be sustained for 10-milliseconds provided the duty cycle does not exceed 10%. The total RMS power must still be limited to 125/160-watts.

### 3.9.4 Short Circuit Protection

A short circuit is defined as an impedance of less than 0.1 ohms placed between DC RETURN and any output. A short circuit will cause no damage to the power supply and will cause it to shutdown. The power supply will periodically attempt to restart until the short circuit condition is removed. After successfully restarting, the power supply will operate normally.

A short circuit on the 12Vaux/-12V output will not cause the power supply to shut down and the output will resume normal operation when the short circuit is removed.

### 3.10 Output Rise Time

All output voltages shall rise from 10% to 90% of nominal output voltage (as specified in Table 3-1) within 0.2ms to 20ms. The output voltages waveform must be a monotonic ramp from 10% to 90% of final set-point within the regulation band under any loading conditions specified in the respective load current tables in Section 6.

For the purposes of this specification, a monotonic ramp is defined as always having a positive slope of from zero to 10\*Vout volts/millisecond. During any 5-millisecond portion of the ramp, its slope must be greater than 5% of its rated voltage per millisecond.

### 3.11 Overshoot At Turn On/Turn Off

The output voltage overshoot upon the application or removal of the input mains voltage is less than 10% above the nominal voltage. No opposite polarity voltage is present on any output during turn-on or turn-off.

### 3.12 Output Transients

The maximum output voltage transient caused by step load changes will not exceed the output voltage regulation limits by more than 5%. With a DC input as specified in Section 2.1, the power supply will remain stable when subjected to the load transients described below:

- Load changes between 75% and 100% on any output
- Load changing repetition of 50 to 333 cycles per second



- Transient load slew rate = 1.0 A/microsecond
- Capacitive loading per Table 3-8

### 3.13 Closed Loop Stability

The power supply is unconditionally stable under all line/load/transient load conditions including the capacitive loads specified in Table 3-8. The power supply shall exhibit a minimum of 45-degrees phase margin and 6 dB gain margin.

### 3.14 Capacitive Loading

The power supply will power up and operate normally with the capacitances listed in Table 3-8 simultaneously present on the outputs. Other values may also provide consistently normal operation but must be tested by the user.

Models	-1DC & -8DC	-05DC	-12DC	-15DC	-24DC	-48DC	-54DC	-56DC
+3.3 V	6,000 $\mu$ F							
+5 V	10,000 $\mu$ F							
+12 V	1,000 $\mu$ F							
-12 V <sub>aux</sub>	350 $\mu$ F	350 $\mu$ F	350 $\mu$ F	350 $\mu$ F	350 $\mu$ F	350 $\mu$ F	350 $\mu$ F	350 $\mu$ F
V1		10,000 $\mu$ F	3,000 $\mu$ F	3,000 $\mu$ F	2,000 $\mu$ F	500 $\mu$ F	500 $\mu$ F	500 $\mu$ F

**Table 3-8 XL125/160DC Capacitive Loading**

# 4.

# General Specifications

## 4.1 Environmental

The XL125/160DC meets or exceeds the following environmental specifications:

Parameter	Conditions	Specification	Remarks
Temperature	Operating	-25°C to 50°C	See cooling requirements
	Non-Operating	-40°C to 85°C	
Relative Humidity	Operating	95% Maximum	Non-Condensing
	Non-Operating	95% Maximum	Non-Condensing
Altitude	Operating	6,561 feet MSL Max.	2,000 meters
	Non-Operating	50,000 feet MSL Max.	15,240 meters
Vibration	No damage	2.4G RMS Maximum	5-500Hz, 10-min. each axis per MIL-PRF-28800F: 3.8.4.1 (Class 3,4)
		6.0G RMS Maximum	100-1,000Hz random, 10-min. vertical axis only
Mechanical Shock	No damage	30G half-sine, 11mS	Six shocks each axis per MIL-PRF-28800F: 4.5.5.4.1

Table 4-1 Environmental Specifications

## 4.2 Mean Time Between Failures

The calculated MTBF of all models except the XL125/160-1,-8DC is equal to or greater than 200,000 hours of continuous operation at maximum output loading and worst case input line voltage with forced-air cooling at 25°C. The XL125/160-1,-8DC is rated at 233,000 hours. N2Power does not warrant the MTBF to be representative of any particular unit. The MTBF of the power supply is calculated with an 80% confidence level in accordance with Telcordia SR-332, Issue 2 at 25°C. Actual failure rates vary from unit to unit.

## 4.3 Component Stress

The XL125/160DC design followed these component-derating guidelines: semiconductor junction temperatures shall not exceed ninety (90) percent of manufacturer's rating with an ambient of 50°C. Inductor winding temperatures shall not exceed safety agency requirements. Capacitor case temperatures shall not exceed 95% of rated temperature. Resistor power dissipation derating is greater than 30%. Component voltage and current derating is greater than 10% at 50°C.

## 4.4 Labeling/Marking

The power supply is marked and labeled with the N2Power logo and part number, model number, input and output specifications, production code, appropriate safety agency logos, CE mark, and country of origin. A typical label is pictured below.



Figure 4-1 Sample Label

## 4.5 Weight

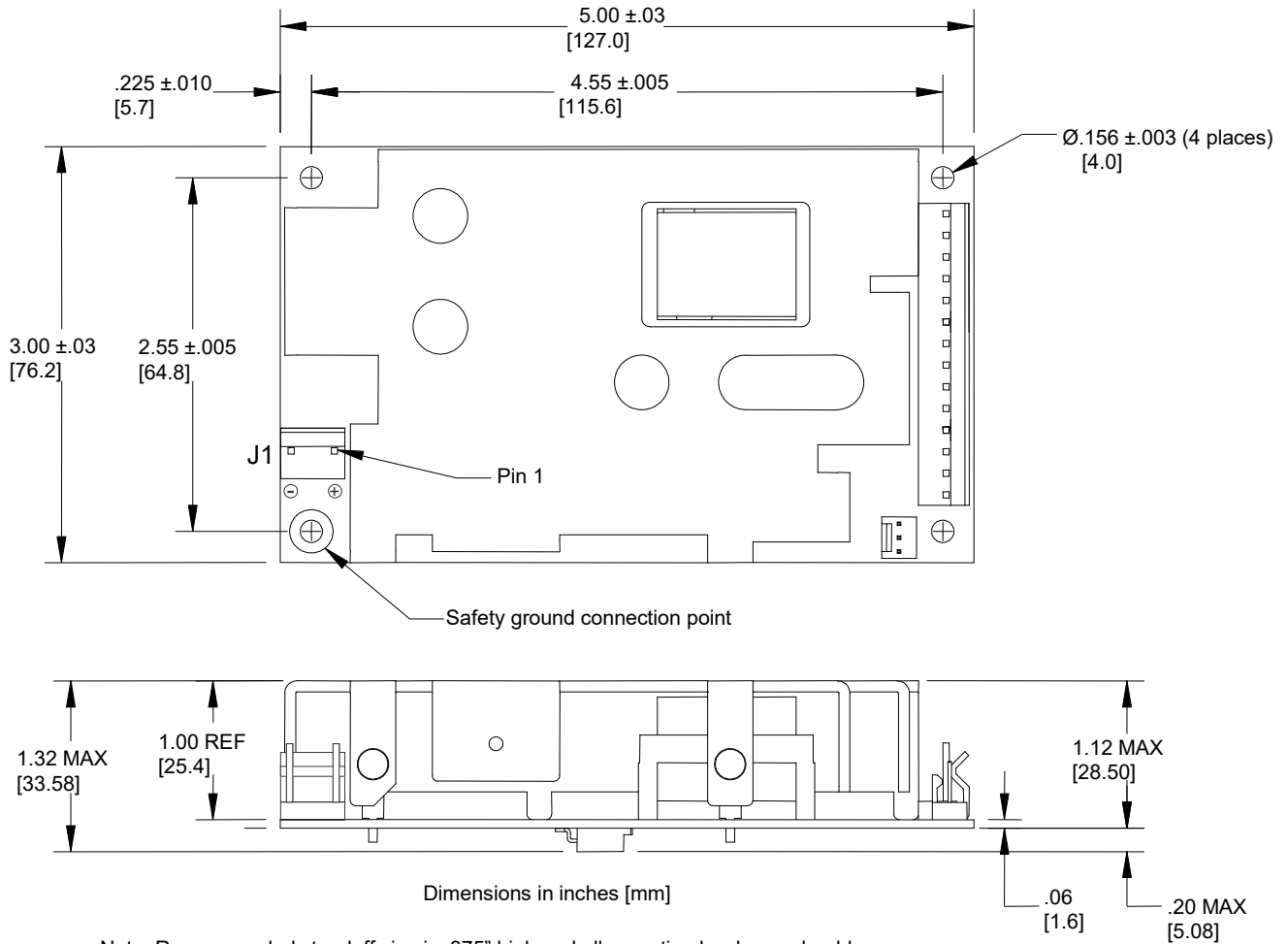
	XL125/XL160-1DC, -8DC	XL125/XL160-05...56DC
Pounds	0.71	0.63
Ounces	11.3	10.0
Kilograms	0.32	0.29

Table 4-2 Net Weight

## 4.6 Mounting

The supply may be mounted in any attitude but must be mounted on all four corners. No. 6 or M3 mounting hardware should not exceed .282-inches (7.16-mm) in diameter for any lockwasher, flat washer, standoff, screw head or other mounting hardware to avoid contact and maintain adequate safety agency spacing requirements with components or printed circuit board traces. The XL125/160DC requires a safety earth connection at the mounting hole nearest J1 (See Figure 4-2). If the standoff is shorter than .250" (6.35mm) an insulator is recommended between the PCBA and chassis.

## 4.7 Physical Dimensions



Note: Recommended standoff size is .375" high and all mounting hardware should be less than .28" in diameter. A standoff less than .375" high is acceptable when a thin insulator, 0.4mm thick (polyester, fish paper or equivalent UL rated 94V-2 minimum) is placed between the power supply and the mounting chassis (refer to applicable UL standard for clearance requirements).

Figure 4-2 XL125/160DC Dimensions (XL125-8DC shown in example)

## 4.8 Mating Connectors

The user must furnish all mating connectors. The mating connectors must meet the requirements of all applicable safety agencies (notably UL). Molex™ (Molex is a trademark of the Molex Corporation) did not change their part numbers when they took the lead out of their contacts. The Molex part numbers in this section should yield RoHS compliant contacts. The largest wire size accepted by each contact should be used for all power connections to help dissipate the heat generated by the resistive connections.

Note that the female contacts that mate to the power supply are only rated for 25-30 mating cycles. Excessive mating cycles causes dramatically increased terminal resistance

and heating resulting in the eventual failure of the mating terminal and possibly the header on the power supply.

### CAUTION

**The pin-1 location differs amongst connector manufacturers. Sometimes pin-1 differs between the header (on the power supply) and the mating housing from the same manufacturer. Disregard the manufacturer's pin-1 location and follow only the pin-1 locations in Figure 4-3.**

#### 4.8.1 DC Input Mating Connector (J1)

The DC input connector is a 3-pin Molex KK-156 style header with 0.156" centers. The center pin is omitted. The Molex part numbers for the mating housing and crimp-style snap-in terminals are listed below. There may be equivalent connectors available from other manufacturers.

J1	Molex P/N
Connector Circuits (pins)	2 of 3
PCB Header (tin)	26-62-4030
Mating Housing	09-50-8031
Rated Contact Current	7.0 A
Crimp Terminal (tin)	08-50-0113
Rated Wire Size	AWG 18 or 20

**Table 4-3 J1 Mating Connector**

#### 4.8.2 DC Output Connector (J2)

Except for the XL125/160-05DC, the DC output connector is a Molex KK-156 style header with 0.156" centers. The Molex part numbers for the mating housing and crimp-style snap-in terminals are listed below. There may be equivalent connectors available from other manufacturers.

J2	XL125/160-1DC, -8DC	XL125/160-05...56DC
Connector Circuits (pins)	14	6
Mating Housing	09-50-8141	09-50-8061
Rated Contact Current	7.0 A	7.0 A
Crimp Terminal (tin)	08-52-0072	08-52-0072
Rated Wire Size	AWG 18 or 20	AWG 18 or 20

**Table 4-4 J2 Mating Connectors**

### 4.8.3 Remote Sense / PG Connector (J3)

The Remote Sense/PG connector on the XL125/160DC is a Molex KK-100 style header with 0.100" centers. The Molex part numbers for the mating housing and crimp-style snap-in terminals are listed below. There may be equivalent connectors available from other manufacturers.

J3	XL125/160-1DC, -8DC	XL125/160-05DC	XL125/160-12...56DC
Connector Circuits (pins)	3	5	6
Mating Housing	22-01-3037	22-01-3057	22-01-3067
Rated Contact Current	2.5 A	2.5 A	2.5 A
Crimp Terminal (tin)	08-50-0114	08-50-0114	08-50-0114
Rated Wire Size	AWG 22-30	AWG 22-30	AWG 22-30

**Table 4-5 J3 Mating Connectors**

### 4.8.4 12V Aux Connector (J4)

The 12V AUX connector found on models XL125/160-05DC through XL125/160-56DC is a 2-pin Molex style header with 0.100" centers. The Molex part numbers for the mating housing and crimp-style snap-in terminals are listed below. There may be equivalent connectors available from other manufacturers.

J4	XL125/160-05...56DC
Connector Circuits (pins)	2
Mating Housing	22-01-3027
Rated Contact Current	2.5 A
Crimp Terminal (tin)	08-50-0114
Rated Wire Size	AWG 22-30

**Table 4-6 12V Aux Mating Connectors**

## 4.9 Output Grounding

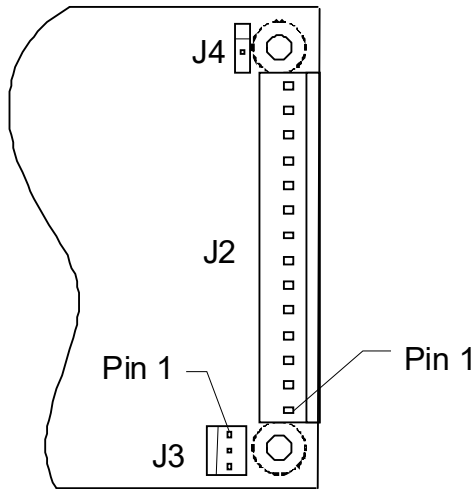
The DC RETURN signal may be connected to the power supply chassis ground (safety ground) at the plated through mounting hole near the input connector.

### 4.10 Signal Pin Definitions

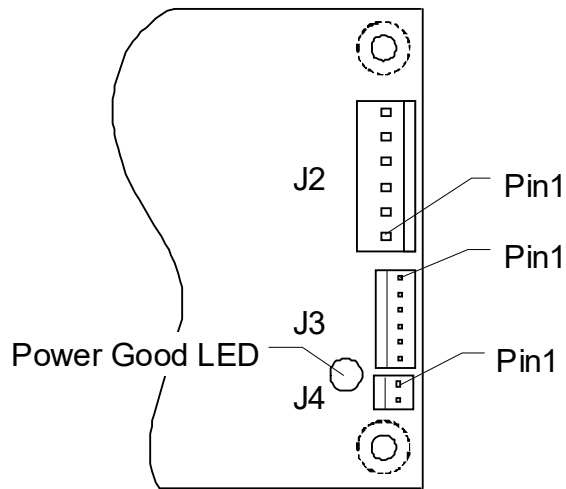
- There are three output connector configurations for the XL125/XL160DC Series
- Identical signal names are connected together on all connectors
- The Auxiliary 12V supply floats only on models XL125/160-12DC through -56DC
- The safety ground connection is provided by the mounting screw near J1
- Refer to Figure 4-3 for connector and pin-1 locations

Pin	XL125/160 -1DC	XL125/160 -8DC	XL160 -05DC	XL125 -05DC	XL125/160 -12 thru -56DC
J1-1	DC + Input	DC + Input	DC + Input	DC + Input	DC + Input
J1-2	No Pin	No Pin	No Pin	No Pin	No Pin
J1-3	DC – Input	DC – Input	DC – Input	DC – Input	DC – Input
J2-1	-12V AUX (Fan)	-12V AUX (Fan)	V1 (+ Output)	V1 (+ Output)	V1 (+ Output)
J2-2	V3 (+12V Output)	V3 (+12V Output)	V1 (+ Output)	V1 (+ Output)	V1 (+ Output)
J2-3	V1 (+3.3V Output)	V3 (+12V Output)	V1 (+ Output)	V1 (+ Output)	V1 (+ Output)
J2-4	V1 (+3.3V Output)	V3 (+12V Output)	DC RETURN (0V)	V1 (+ Output)	DC RETURN (0V)
J2-5	V1 (+3.3V Output)	V3 (+12V Output)	DC RETURN (0V)	V1 (+ Output)	DC RETURN (0V)
J2-6	DC RETURN (0V)	DC RETURN (0V)	DC RETURN (0V)	DC RETURN (0V)	DC RETURN (0V)
J2-7	DC RETURN (0V)	DC RETURN (0V)		DC RETURN (0V)	
J2-8	DC RETURN (0V)	DC RETURN (0V)		DC RETURN (0V)	
J2-9	DC RETURN (0V)	DC RETURN (0V)		DC RETURN (0V)	
J2-10	DC RETURN (0V)	DC RETURN (0V)		DC RETURN (0V)	
J2-11	V2 (+5V Output)	V2 (+5V Output)			
J2-12	V2 (+5V Output)	V2 (+5V Output)			
J2-13	V2 (+5V Output)	V2 (+5V Output)			
J2-14	V2 (+5V Output)	V2 (+5V Output)			
J3-1	0V Sense (–)	0V Sense (–)	Current Share	Current Share	DC RETURN (0V)
J3-2	V1 Sense (+)	V1 Sense (+)	0V Sense (–)	0V Sense (–)	0V Sense (–)
J3-3	Power Good	Power Good	V1 Sense (+)	V1 Sense (+)	V1 Sense (+)
J3-4			PS_OK	PS_OK	Current Share
J3-5			Power Good	Power Good	Power Good
J3-6					PS_OK
J4-1	V2 Sense (+)	V2 Sense (+)	12V AUX (+) (Fan)	12V AUX (+) (Fan)	12V AUX (+) (Fan)
J4-2	No Pin	No Pin	12V AUX (–) (Fan)	12V AUX (–) (Fan)	12V AUX (–) (Fan)

**Table 4-7 Signal Pin Definitions**

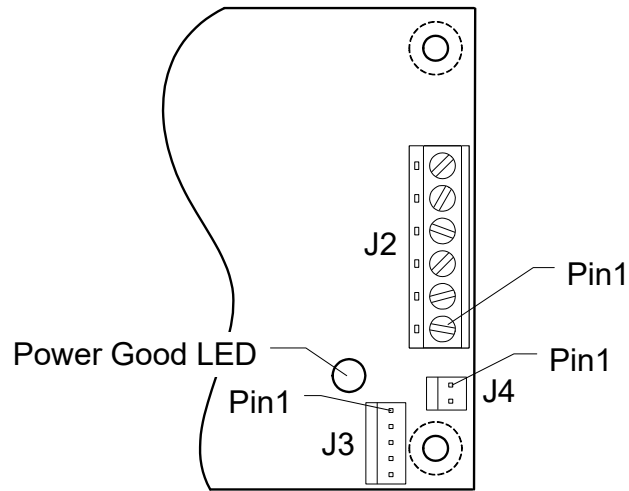


**Figure 4-3 XL125/160-1DC, -8DC Output Connectors Layout**

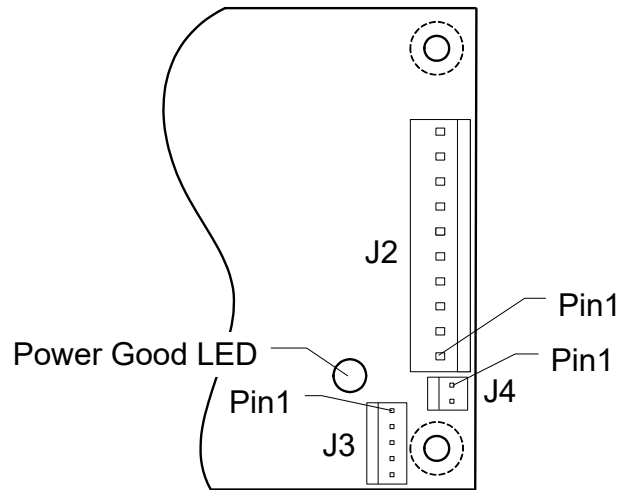


**Figure 4-4 XL125/160-12...56DC [CS] Output Connectors Layout**





**Figure 4-5 XL160-05DC [CS] Output Connectors Layout**



**Figure 4-6 XL125-05DC [CS] Output Connectors Layout**

# 5.

# Efficiency

## 5.1 XL125-1, -8DC Efficiency

The power supply efficiency varies with the following: input voltage, total output load, load distribution and between individual units. The following graph shows the typical efficiency with forced air cooling air at 25°C after a 15-minute warm-up period. The percentage of the total load contributed by each output is shown in Table 5-1 and Table 5-2.

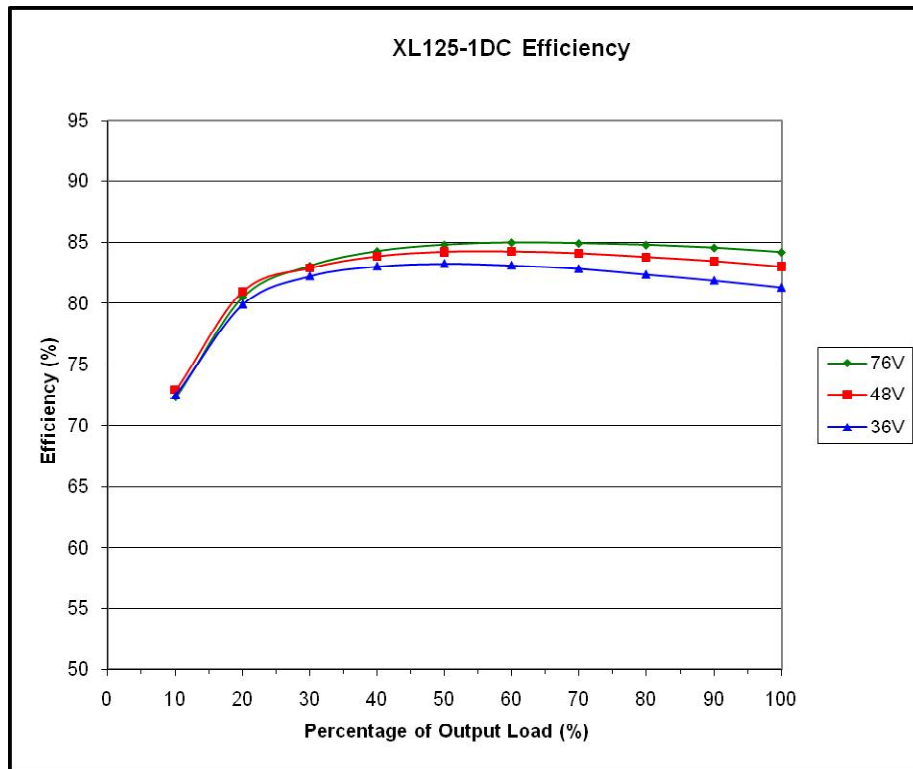
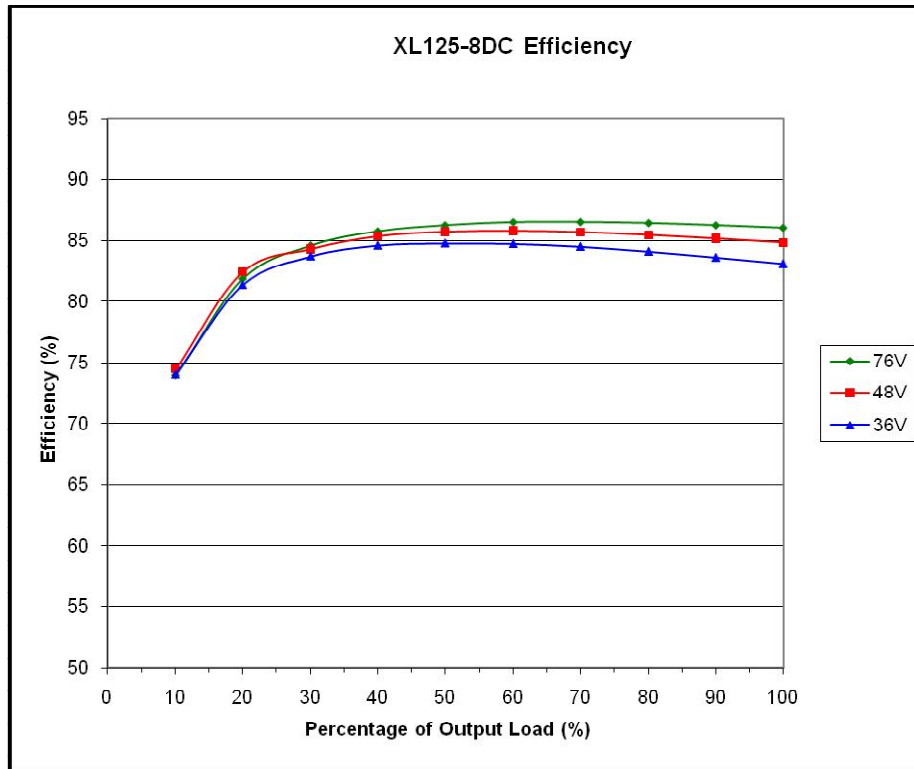


Figure 5-1 Efficiency of XL125-1DC (Non Current Sharing)

Output	Rated Voltage	Tested Current Load
V1	+3.3 V	8.18A
V2	+5 V	10.00A
V3	+12 V	3.00A
V4	-12 V	1.00A

Table 5-1 Load Distribution used for Efficiency Measurements for XL125-1DC



**Figure 5-2 Efficiency of XL125-8DC (Non Current Sharing)**

<b>Output</b>	<b>Rated Voltage</b>	<b>Tested Current Load</b>
V1	+3.3 V	—
V2	+5 V	13.00A
V3	+12 V	4.00A
V4	-12 V	1.00A

**Table 5-2 Load Distribution used for Efficiency Measurements for XL125-8DC**

## 5.2 XL125-05DC Efficiency

The power supply efficiency varies with the following: input voltage, total output load, and between individual units. The following graphs show the typical efficiency with forced air cooling air at 25°C after a 15-minute warm-up period.

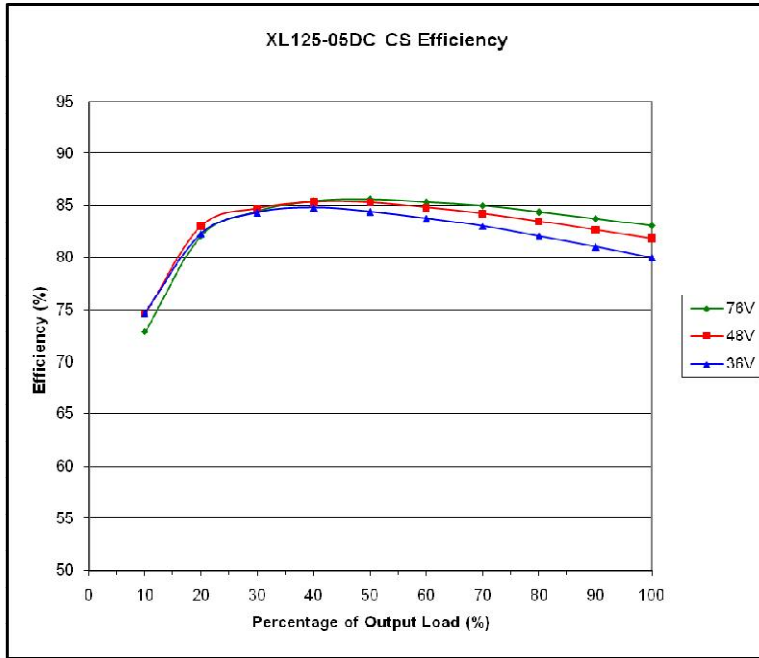


Figure 5-3 Efficiency of XL125-05DC CS (Current Sharing)

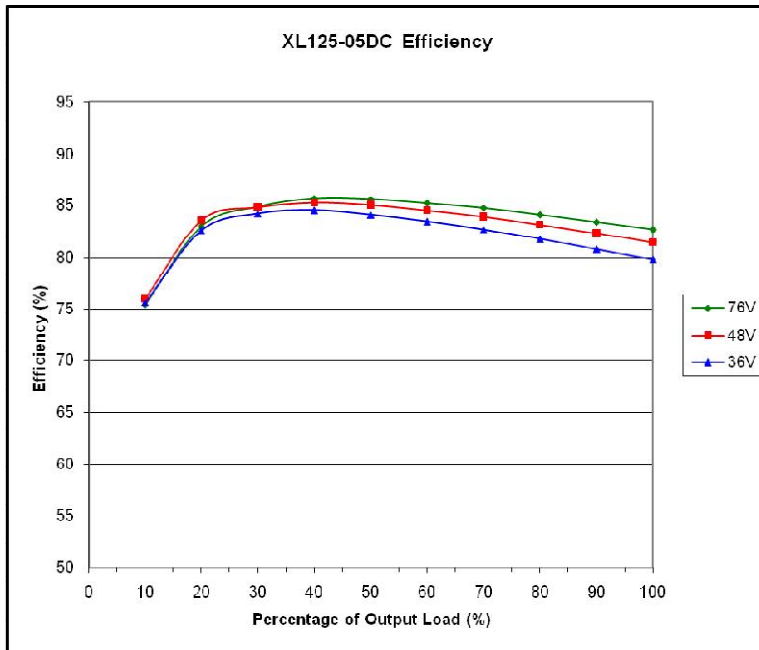


Figure 5-4 Efficiency of XL125-05DC (Non Current Sharing)

### 5.3 XL125-12...56DC Efficiency

The power supply efficiency varies with the following: input voltage, total output load, and between individual units. The following graphs show the typical efficiency with forced air cooling air at 25°C after a 15-minute warm-up period.

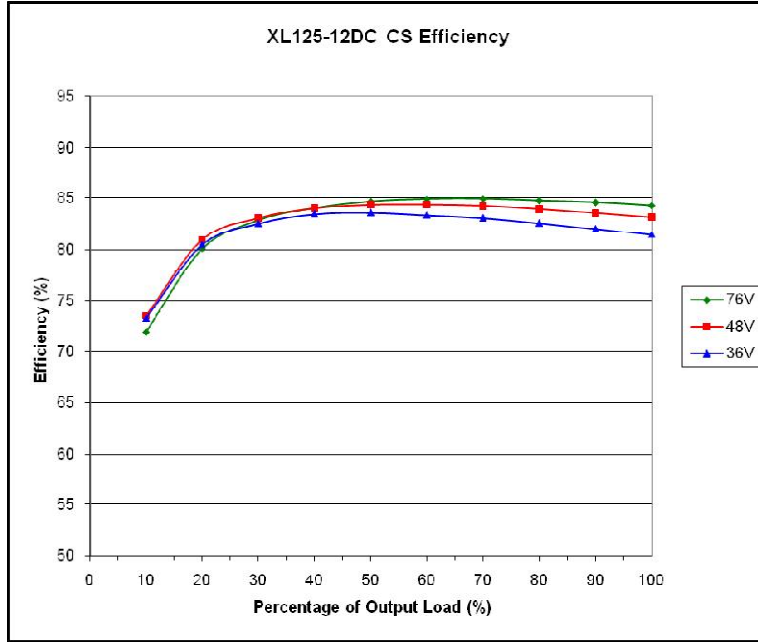


Figure 5-5 Efficiency of XL125-12DC CS (Current Sharing)

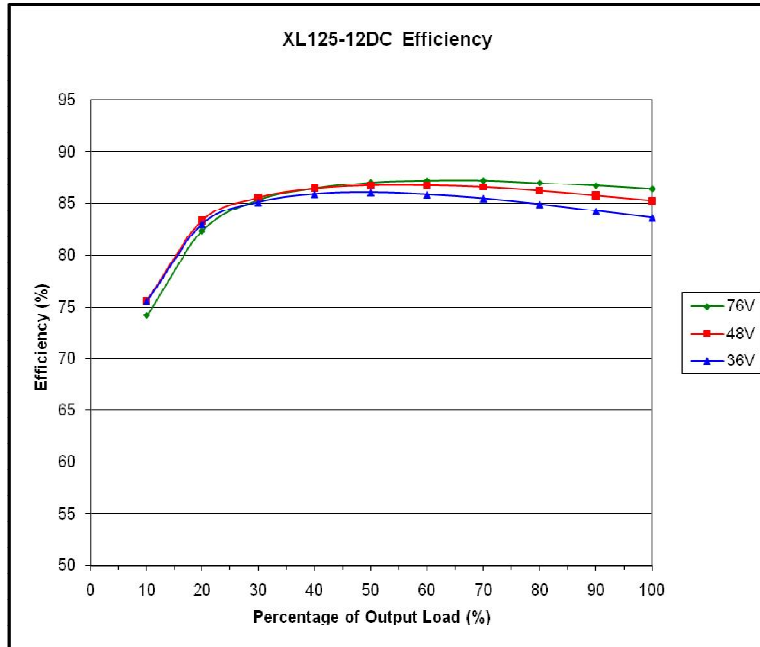


Figure 5-6 Efficiency of XL125-12DC (Non Current Sharing)

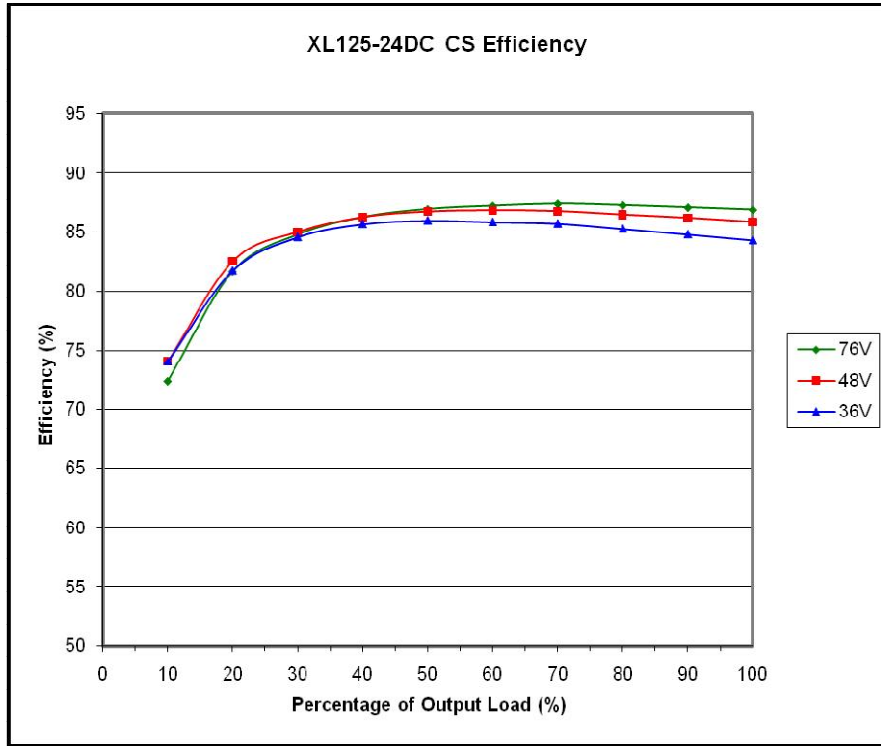


Figure 5-7 Efficiency of XL125-24DC CS (Current Sharing)

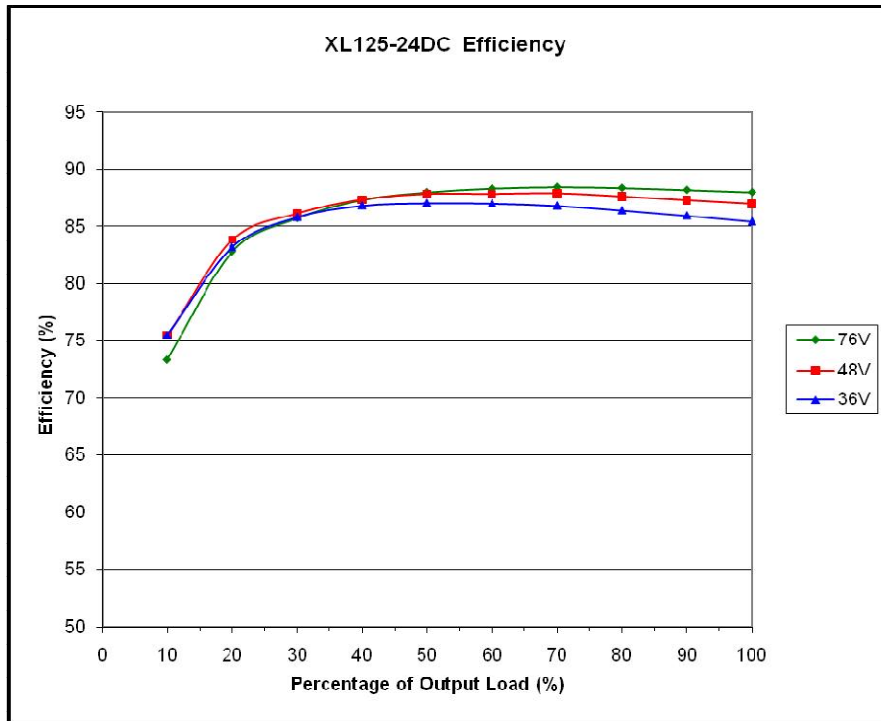
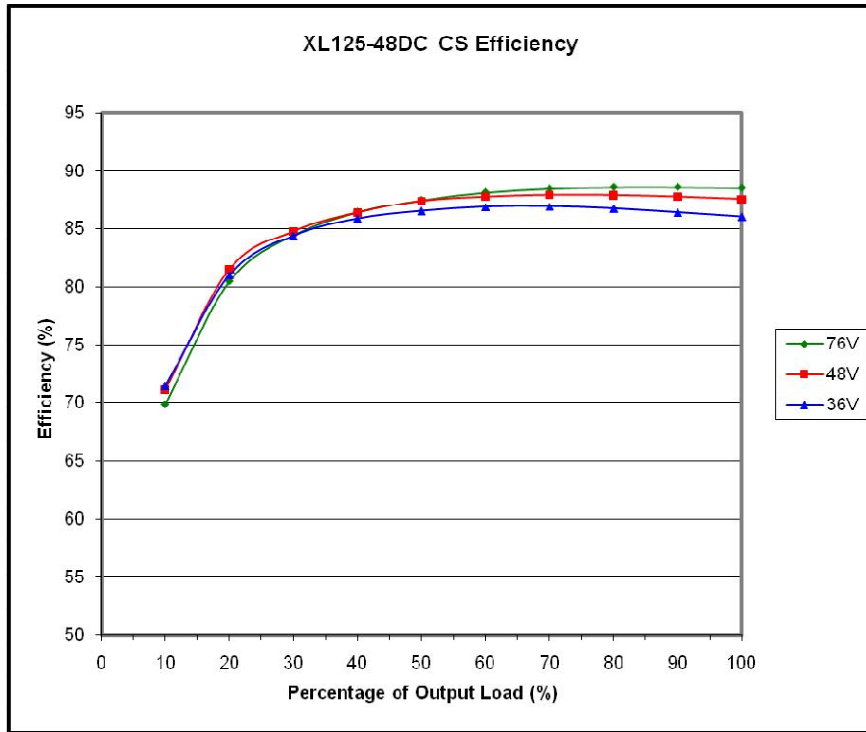
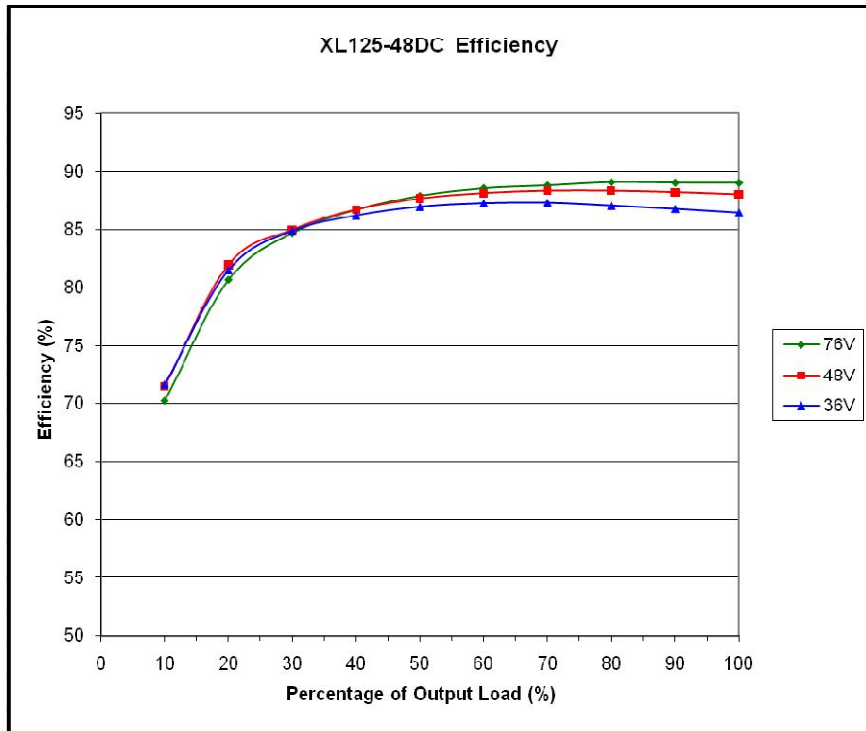


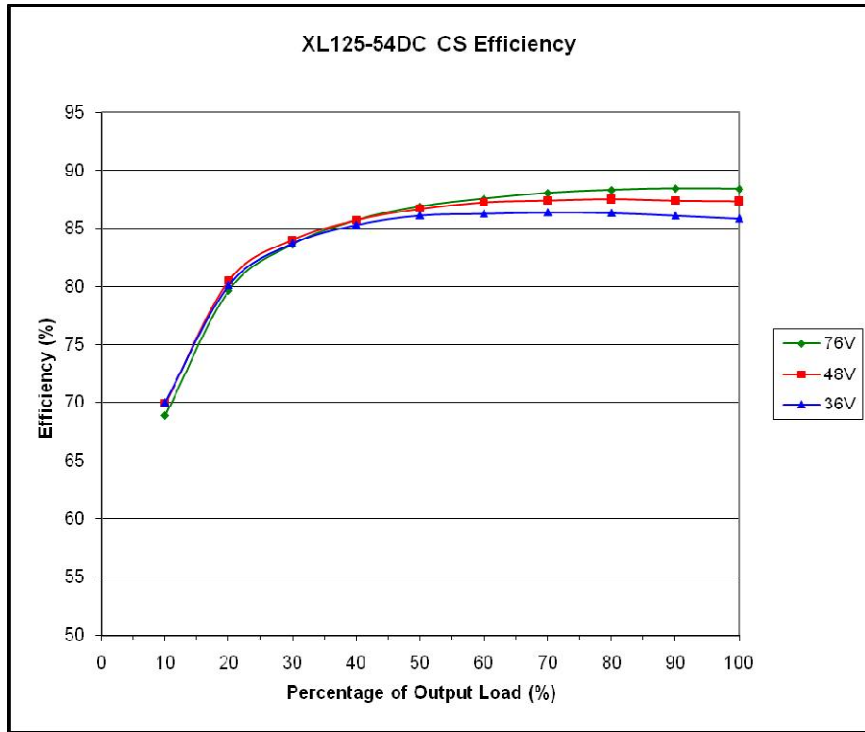
Figure 5-8 Efficiency of XL125-24DC (Non Current Sharing)



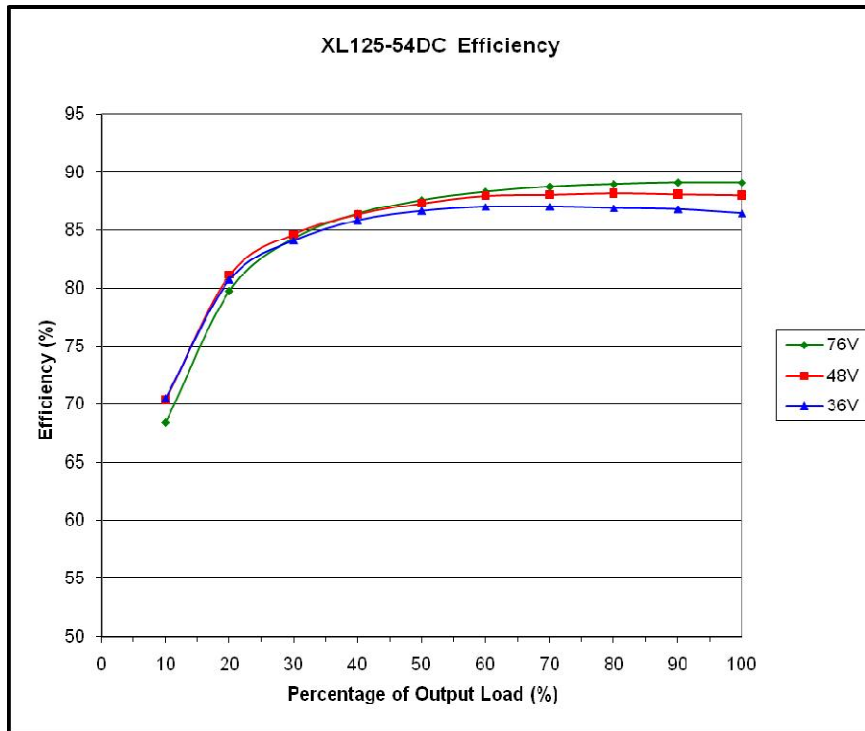
**Figure 5-9 Efficiency of XL125-48DC CS (Current Sharing)**



**Figure 5-10 Efficiency of XL125-48DC (Non Current Sharing)**

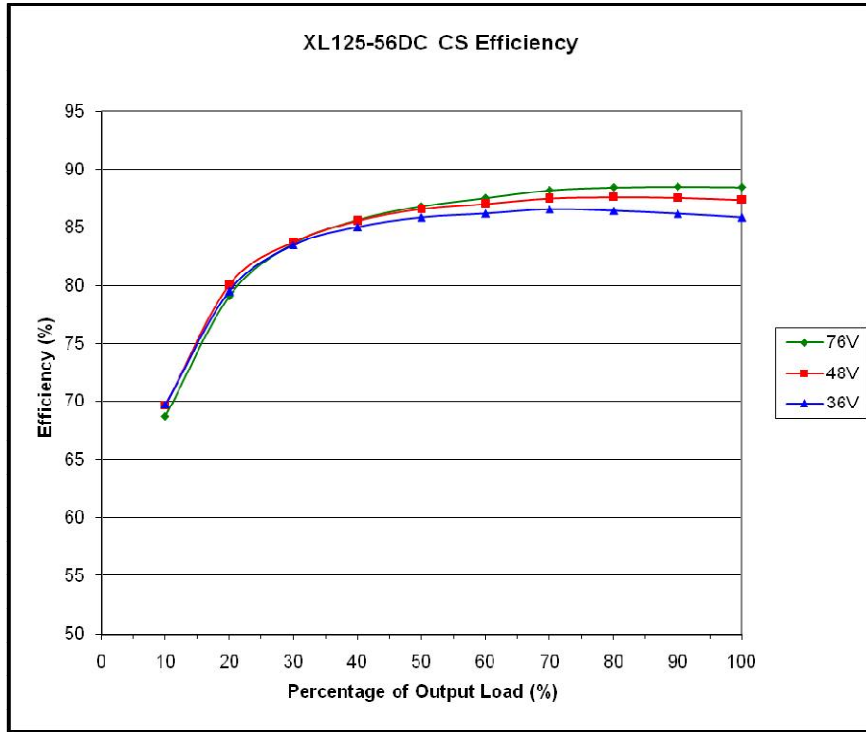


**Figure 5-11 Efficiency of XL125-54DC CS (Current Sharing)**

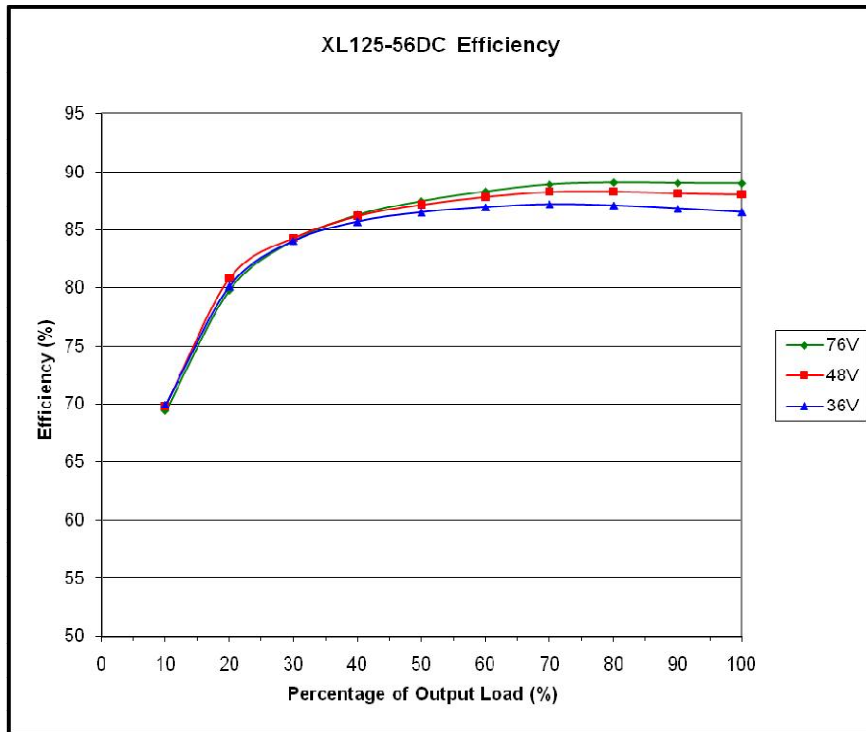


**Figure 5-12 Efficiency of XL125-54DC (Non Current Sharing)**





**Figure 5-13 Efficiency of XL125-56DC CS (Current Sharing)**



**Figure 5-14 Efficiency of XL125-56DC (Non Current Sharing)**

## 5.4 XL160-1, -8DC Efficiency

The power supply efficiency varies with the following: input voltage, total output load, and between individual units. The following graphs show the typical efficiency with forced air cooling air at 25°C after a 15-minute warm-up period. The percentage of the total load contributed by each output is shown in Table 5-3 and Table 5-4.

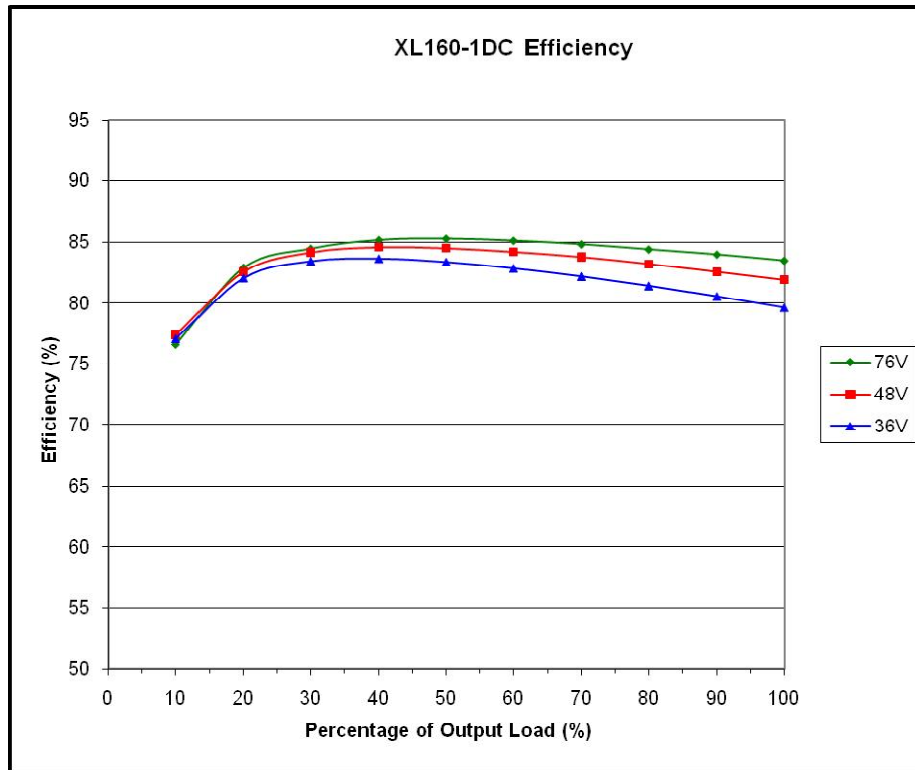
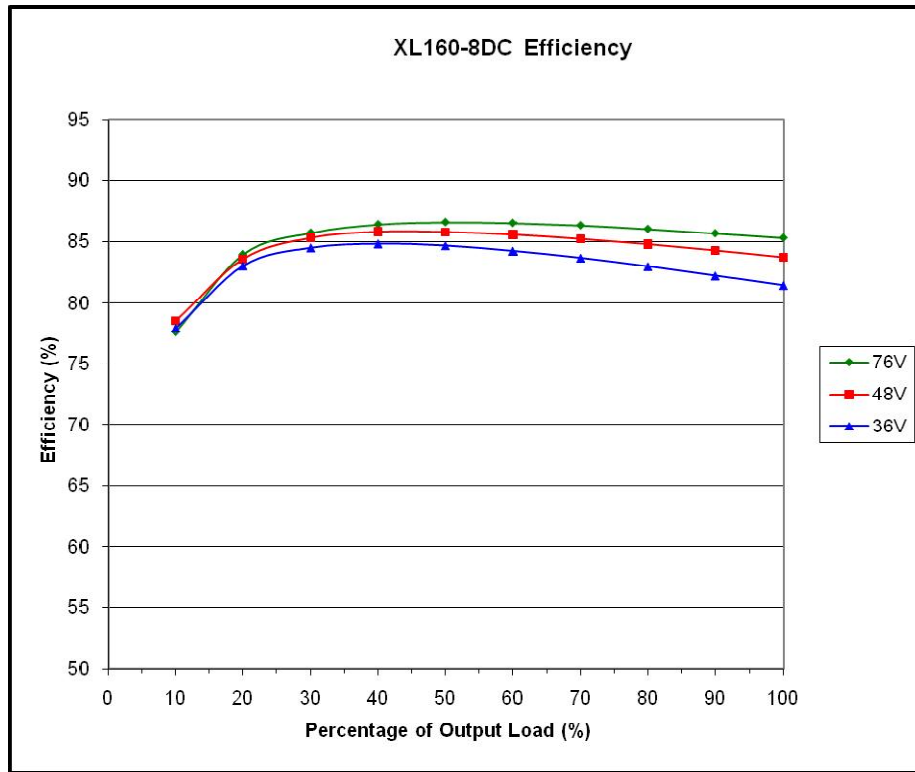


Figure 5-15 Efficiency of XL160-1DC (Non Current Sharing)

Output	Rated Voltage	Tested Current Load
V1	+3.3 V	10.0A
V2	+5 V	13.5A
V3	+12 V	4.0A
V4	-12 V	1.0A

Table 5-3 Load Distribution used for Efficiency Measurements for XL160-1DC



**Figure 5-16 Efficiency of XL160-8DC (Non Current Sharing)**

<b>Output</b>	<b>Rated Voltage</b>	<b>Tested Current Load</b>
V1	+3.3 V	—
V2	+5 V	17.6A
V3	+12 V	5.0A
V4	-12 V	1.0A

**Table 5-4 Load Distribution used for Efficiency Measurements for XL160-8DC**

## 5.5 XL160-05DC Efficiency

The power supply efficiency varies with the following: input voltage, total output load, and between individual units. The following graphs show the typical efficiency with forced air cooling air at 25°C after a 15-minute warm-up period.

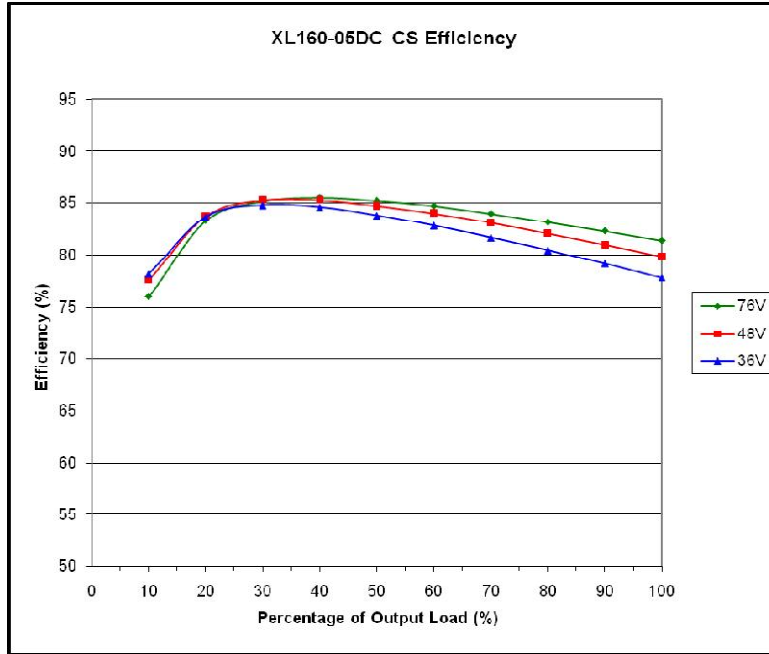


Figure 5-17 Efficiency of XL160-05DC CS (Current Sharing)

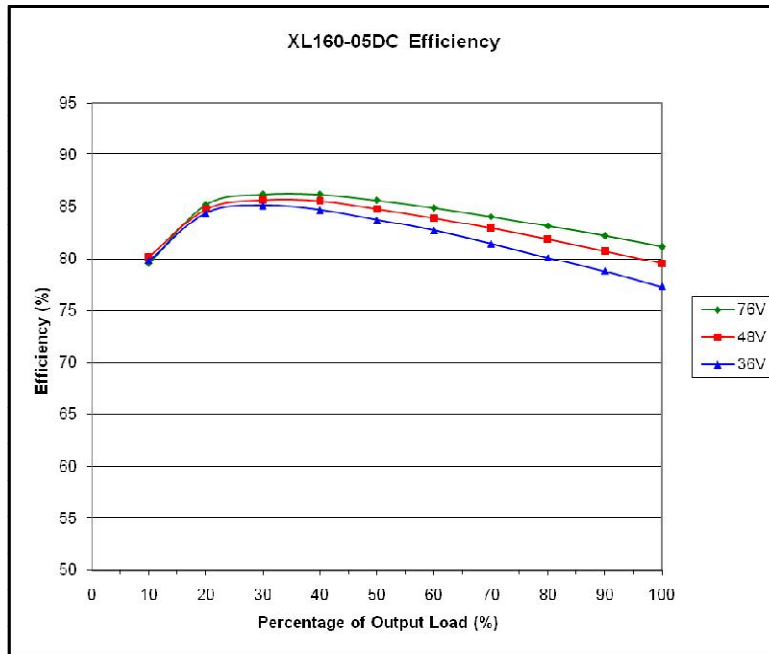
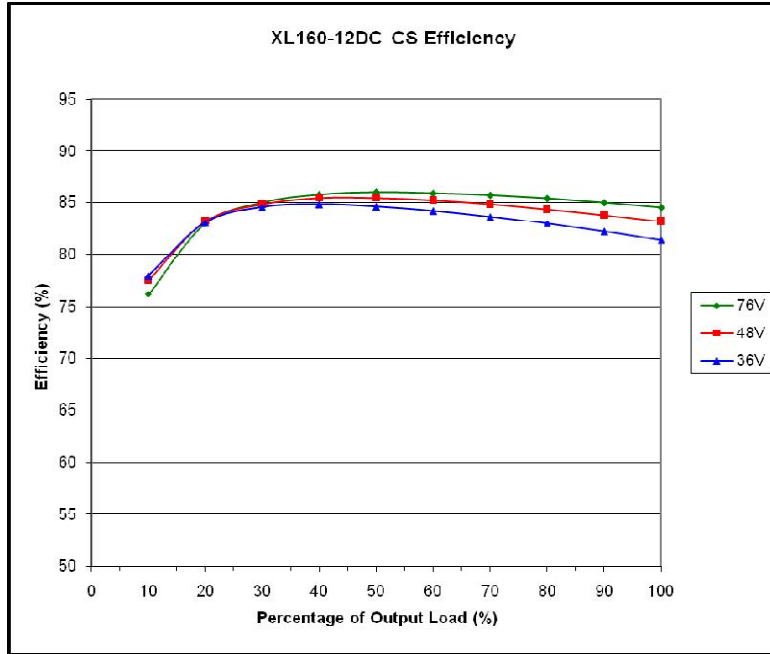


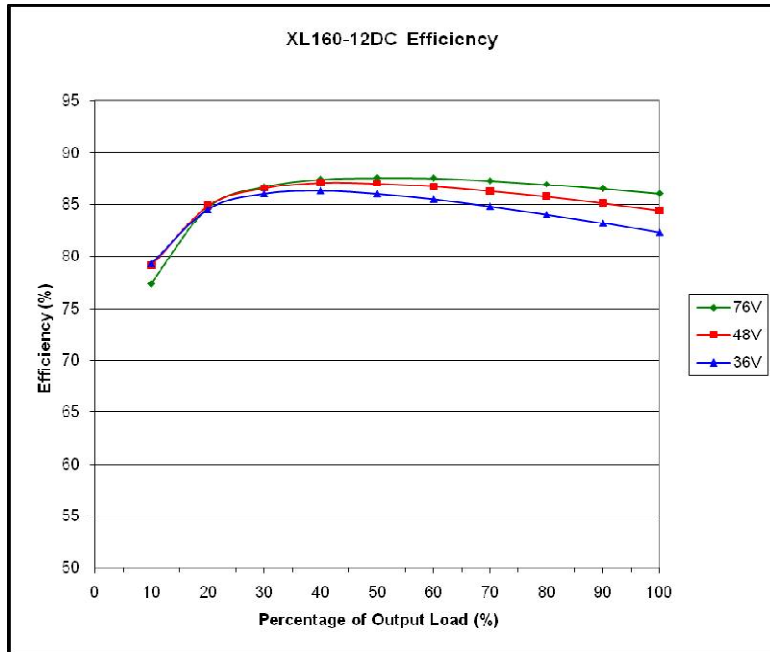
Figure 5-18 Efficiency of XL160-05DC (Non Current Sharing)

## 5.6 XL160-12...56DC Efficiency

The power supply efficiency varies with the following: input voltage, total output load, and between individual units. The following graphs show the typical efficiency with forced air cooling air at 25°C after a 15-minute warm-up period.



**Figure 5-19 Efficiency of XL160-12DC CS (Current Sharing)**



**Figure 5-20 Efficiency of XL160-12DC (Non Current Sharing)**

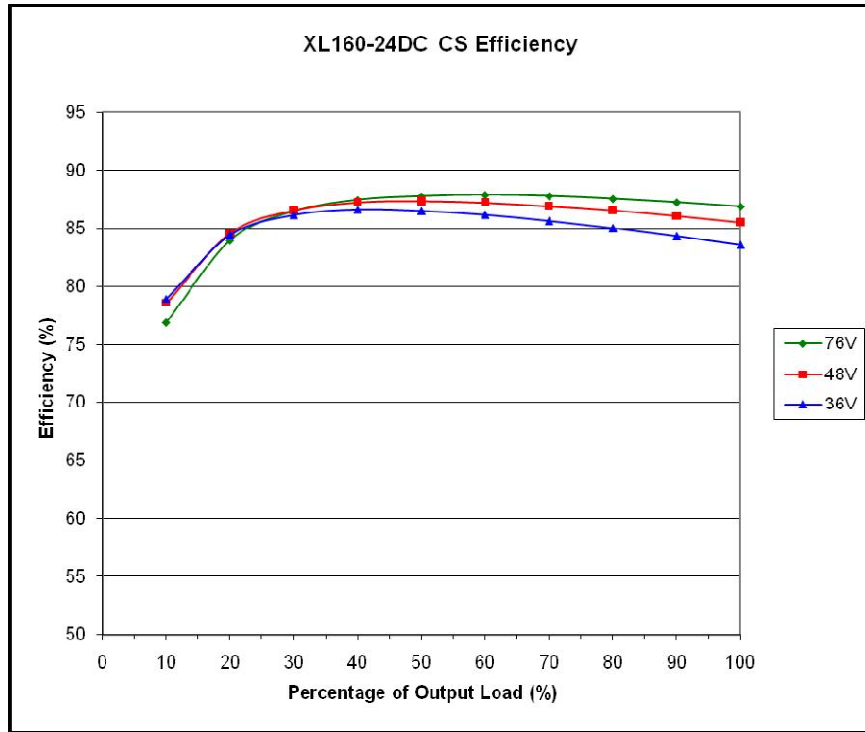


Figure 5-21 Efficiency of XL160-24DC CS (Current Sharing)

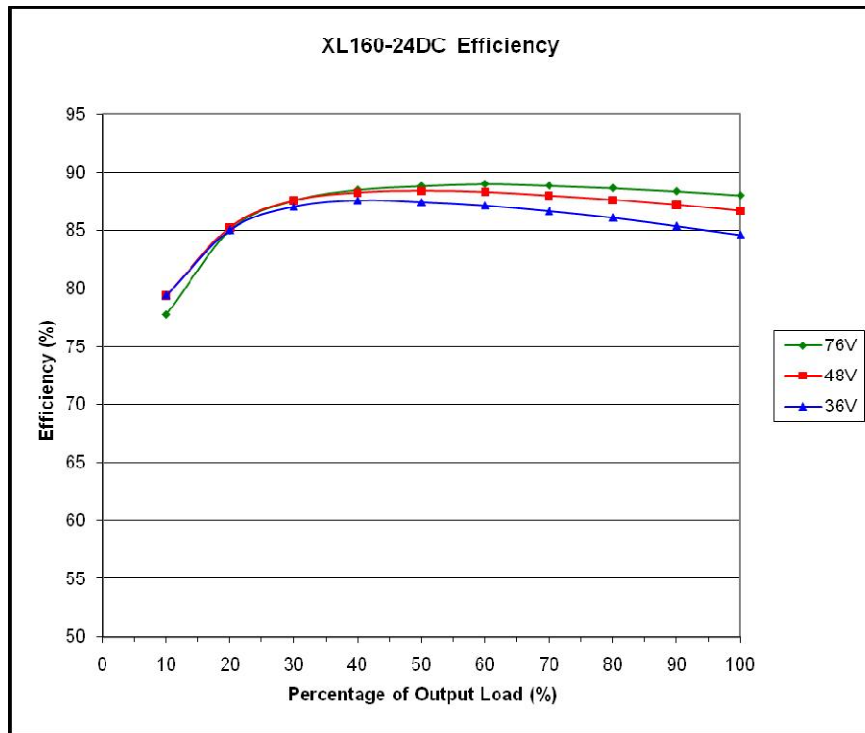


Figure 5-22 Efficiency of XL160-24DC (Non Current Sharing)

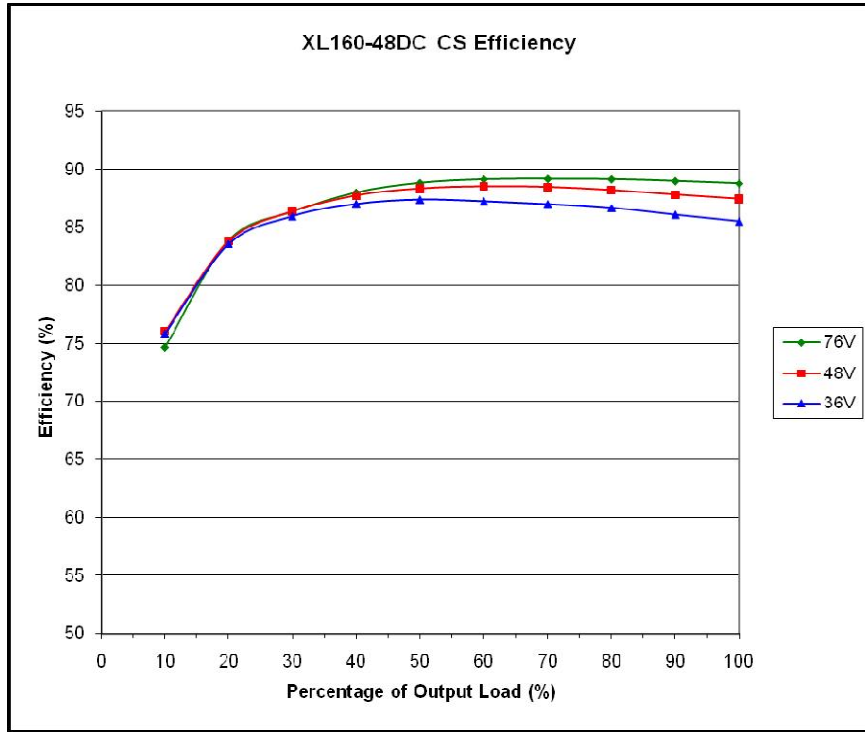


Figure 5-23 Efficiency of XL160-48DC CS (Current Sharing)

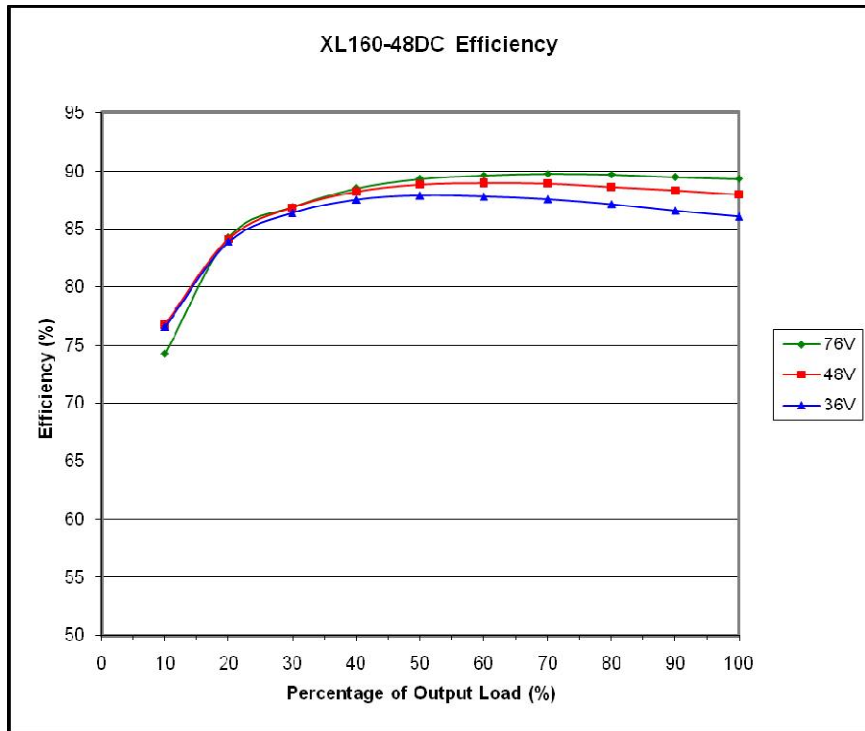


Figure 5-24 Efficiency of XL160-48DC (Non Current Sharing)

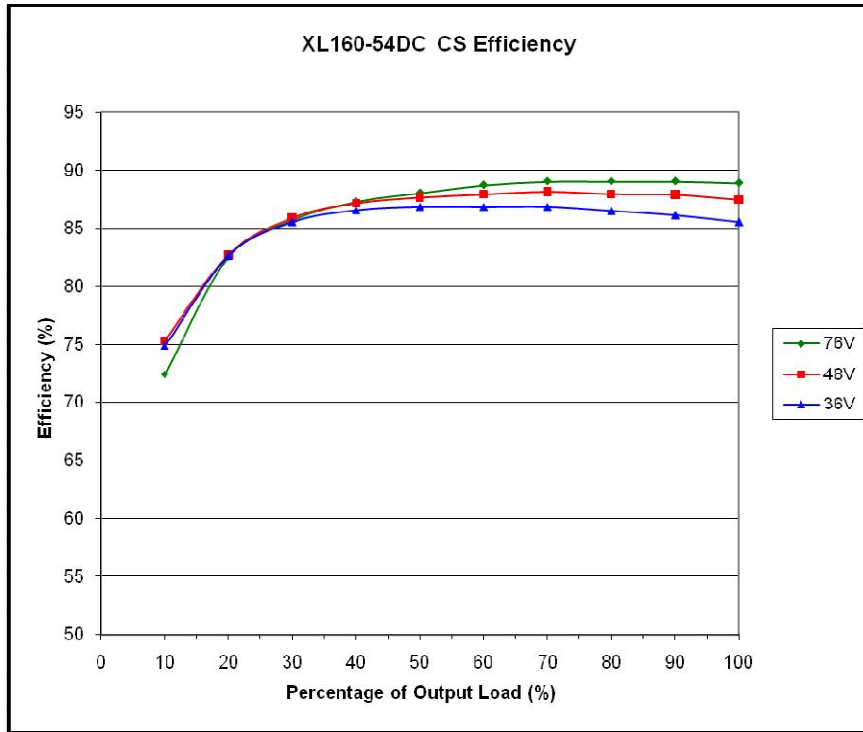


Figure 5-25 Efficiency of XL160-54DC CS (Current Sharing)

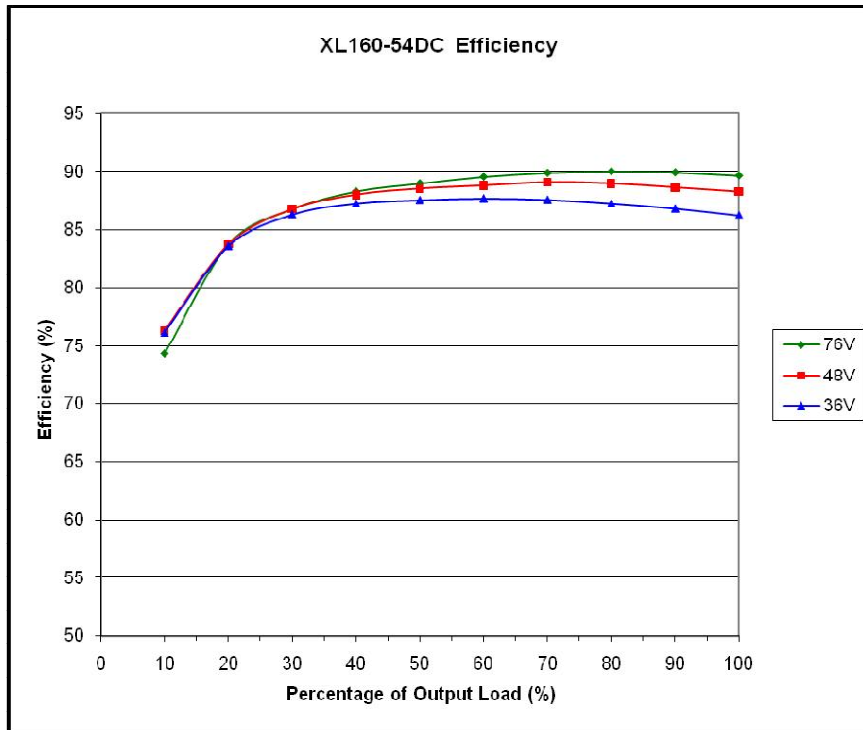


Figure 5-26 Efficiency of XL160-54DC (Non Current Sharing)



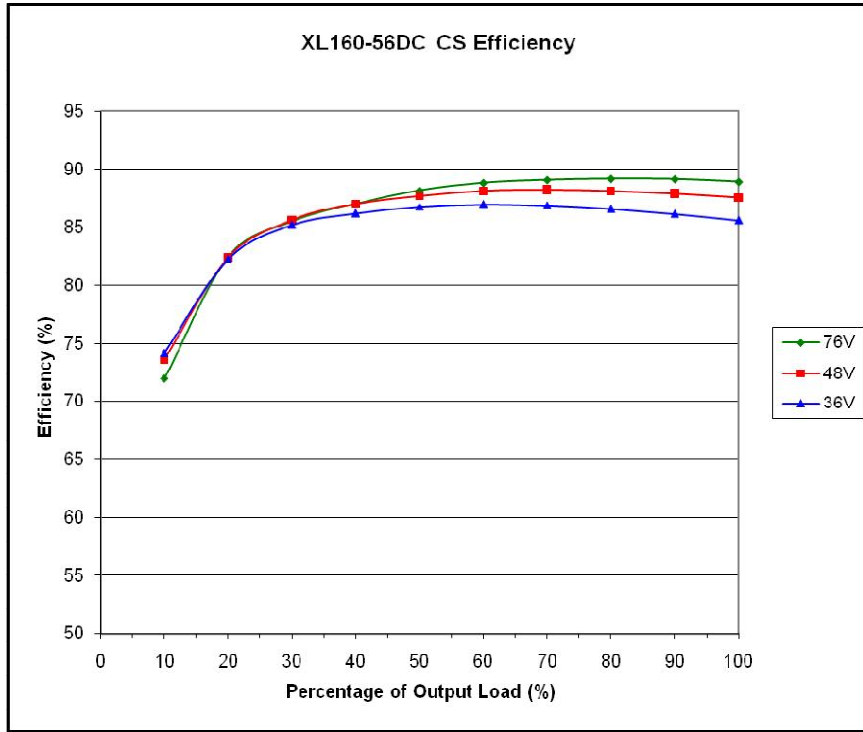


Figure 5-27 Efficiency of XL160-56DC CS (Current Sharing)

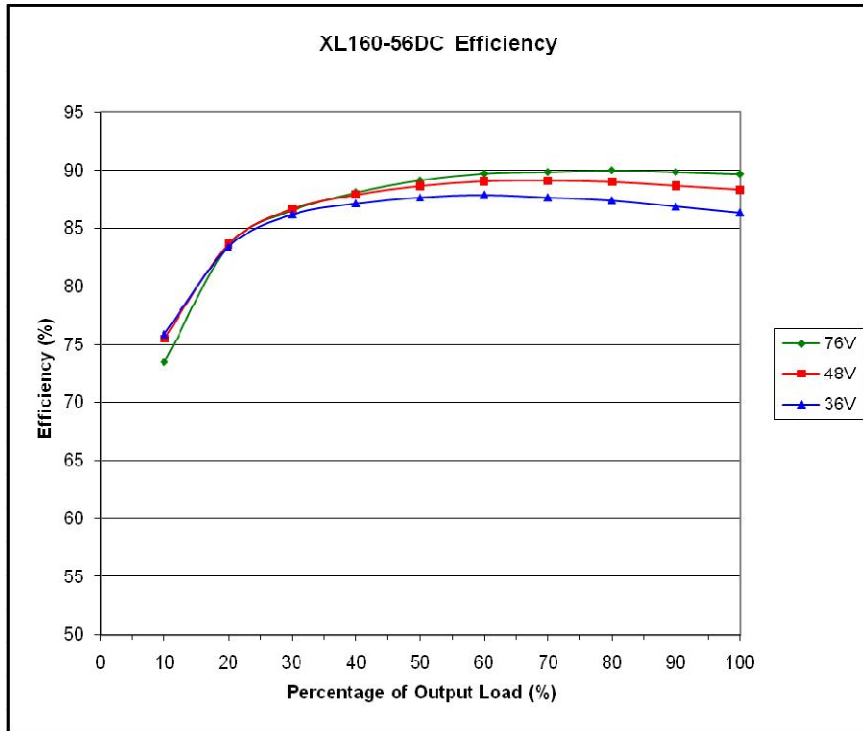


Figure 5-28 Efficiency of XL160-56DC (Non Current Sharing)

# 6.

# Timing and Control

## 6.1 Power Supply Timing

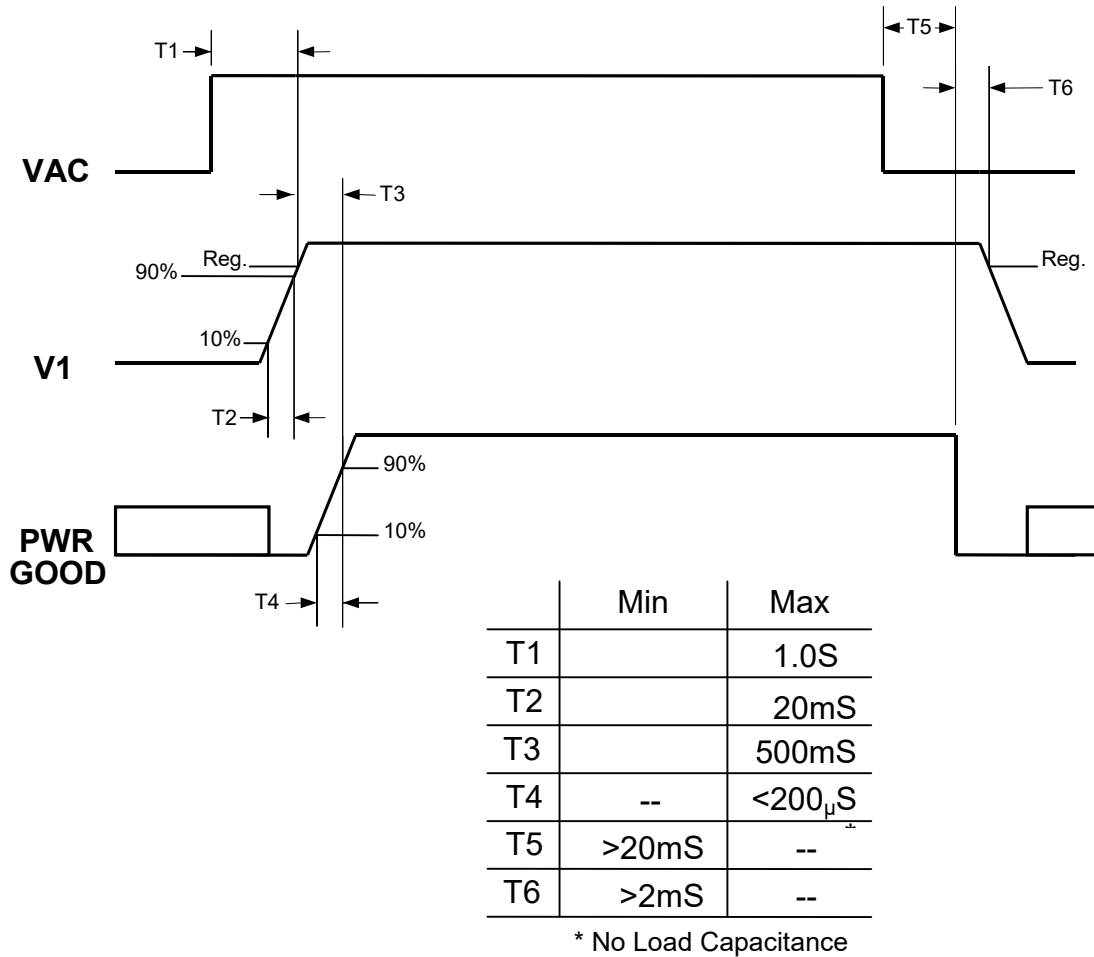


Figure 6-1 Timing Diagram

## 6.2 Power Good Signal/PS\_OK Signal/Remote ON Input

The Power Good Signal provides a high logic level to indicate that sufficient time has expired for the DC outputs to be within their regulation limits. When the input power is removed, the Power Good Signal transitions to a low logic level. The PS\_OK signal is the logical complement of the Power Good signal and both signals are driven by open-collector transistors. XL125/160-1DC and -8DC models add a TTL compatible pull-up resistor on just the Power Good output. The electrical specifications for the Power Good and PS\_OK outputs are described in Table 6-1.

Signal Type	+5VDC, TTL Compatible
Low Logic Level	<0.4V when sinking 4mA
High Logic Level	Open Collector Output (see next)
Power Good Pullup Resistor	TTL compatible only on XL125/160-1DC and -8DC models
Power On Delay	Less than 500mS after V1 outputs reaches regulation
Power Down Warning	>2 mS before V1 reaches minimum regulated output
Rise Time	<200 $\mu$ S from 10% to 90% point.
PS_OK	Logical complement of Power Good signal. Open collector output without a pull-up resistor

**Table 6-1 Status Signal Specifications**

### 6.3 Power Good LED

A green LED on XL160-05DC through -56DC models illuminates whenever the Power Good signal is true (high). See Figure 4-3 for the LED location near the output connector.

### 6.4 Power Sequencing: XL125/160-1DC and XL125/160-8DC

The +12V and +5V output voltages are equal to or greater than the V1 (+2.5V or +3.3V) output voltage at all times during power up and normal operation. The time between the +5V output reaching minimum in-regulation voltage and the V1 output reaching minimum in-regulation voltage shall be less than 20 milliseconds.

# 7.

# Ordering Information

The following table provides the N2Power part numbers that should appear on your purchase order and will appear on all N2Power correspondence:

Main Outputs	125-W Versions		160-Watt Versions	
	Model Number	Part Number	Model Number	Part Number
Without active current sharing (lower cost)				
+3.3V, +5V, +12V, -12V	XL125-1DC	400070-61-1	XL160-1DC	400080-01-6
+5V, +12V, -12V	XL125-8DC	400070-68-6	XL160-8DC	400080-08-1
5V	XL125-05DC	400071-01-5	XL160-05DC	400083-02-8
12V	XL125-12DC	400071-63-5	XL160-12DC	400083-03-6
15V	XL125-15DC	400071-64-3	XL160-15DC	400083-04-4
24V	XL125-24DC	400071-65-0	XL160-24DC	400083-05-1
48V	XL125-48DC	400071-66-8	XL160-48DC	400083-06-9
54V POE	XL125-54DC	400071-67-6	XL160-54DC	400083-07-7
56V POE	XL125-56DC	400071-68-4	XL160-56DC	400083-08-5
With active current sharing				
5V	XL125-05DC CS	400070-01-7	XL160-05DC CS	400080-02-4
12V	XL125-12DC CS	400070-63-7	XL160-12DC CS	400080-03-2
15V	XL125-15DC CS	400070-64-1	XL160-15DC CS	400080-04-0
24V	XL125-24DC CS	400070-65-2	XL160-24DC CS	400080-05-7
48V	XL125-48DC CS	400070-66-0	XL160-48DC CS	400080-06-5
54V POE	XL125-54DC CS	400070-69-4	XL160-54DC CS	400080-09-9
56V POE	XL125-56DC CS	400070-70-2	XL160-56DC CS	400080-10-7

POE Models provide 1500VDC output isolation while the others are rated at 50V.

**Table 7-1 XL125/XL160-DC Model and Part Numbers**

All XL125/XL160-DC models are RoHS compliant. For warranty information refer to [www.n2power.com](http://www.n2power.com). Direct all questions, orders or requests for quotation as follows:

N2Power Order Desk: [orders@n2power.com](mailto:orders@n2power.com)  
 805-583-7744 x112

Fax (Attention N2Power): 805-978-5212

Sales: [sales@n2power.com](mailto:sales@n2power.com)  
 805-583-7744 x122

Technical Support: [techsupport@n2power.com](mailto:techsupport@n2power.com)  
 805-583-7744 x119

Street Address: 1267 Flynn Road  
 Camarillo, CA 93012